



Standard Color



Optional Color

7FB

SERIES

MAIN SPECIFICATIONS

Model		7FB10 (7FBH10)	7FB14 (7FBH14)	7FB15 (7FBH15)	40-7FB15	7FB18 (7FBH18)	7FB20 (7FBH20)	40-7FB20
Load Capacity	kg	1000	1350	1500	1500	1750	2000	2000
Load Center	mm	500	500	500	500	500	500	500
Overall Width	A mm	1060	1060	1115	1170	1115	1170	1150
Turning Radius (Outside)	B mm	1750	1760	1770	1980	1780	1980	2145
Overhead Guard Height	C mm	2025 (2105)	2025 (2105)	2025 (2105)	2105	2025 (2105)	2025 (2105)	2160
Length to Fork Face	D mm	2075	2080	2080	2216	2115	2240	2405

Model		7FB25 (7FBH25)	40-7FB25	7FB30	7FBJ35
Load Capacity	kg	2500	2500	3000	3500
Load Center	mm	500	500	500	500
Overall Width	A mm	1170	1150	1240	1240
Turning Radius (Outside)	B mm	2000	2170	2210	2270
Overhead Guard Height	C mm	2025 (2105)	2160	2195	2195
Length to Fork Face	D mm	2290	2435	2490	2575

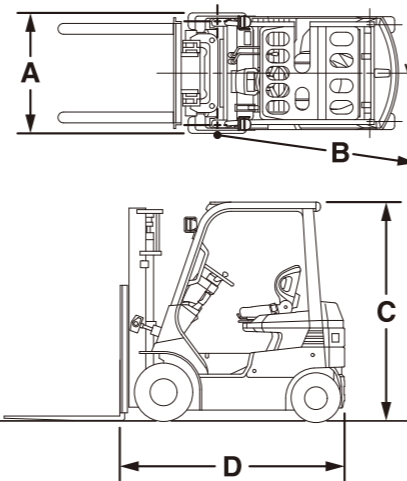

BATTERY AND MOTOR SPECIFICATIONS

Model		7FB10.14	7FB15.18	7FBH10.14 7FBH15.18	40-7FB15	7FB20	7FB25	7FBH20.25	40-7FB 20.25	7FB30 7FBJ35
Voltage/Capacity (5-hour ratings)	STD	V/AH	48/330	48/400	48/545	48/600	48/450	48/565	48/730	48/845
	High	V/AH	48/485	48/485	—	48/730	48/600	48/600	—	—
Electric Motors	Drive	kW	7.6	7.6	7.6	10.7	10.7	10.7	10.7	11.9
	Load Handling	kW	9.5	9.5	9.5	12.2	12.2	12.2	12.2	14.4
	Power Steering	kW	0.9	0.9	0.9	0.9	1.0	1.0	1.0	1.2

The data in this brochure is determined based on our standard testing condition.
The performance may vary depending on the actual specification and condition of the vehicle as well as the condition of the operating area.
Availability and specifications depend on region and are subject to change without notice.
Due to photography and printing, color of actual vehicle may vary from this brochure. Some photos have been computer-enhanced.
Please consult your Toyota representative for details.

All rights reserved by Toyota Industries Corporation.



AC Power System and SAS Provide

Originally Innovative Always Advancing

The 7FB is the first Toyota forklift to harness the benefits of the AC Power System and the System of Active Stability (SAS). With its original and innovative design that incorporates state-of-the-art Toyota engineering, the 7FB has been setting the new world standard for electric forklifts since its launch. Even after years of field-proven performance, the 7FB remains a leader in innovation and performance.

In the wide range of Productivity PLUS options you will find more examples of how Toyota engineering excellence offers specialized solutions for boosting productivity at your workplace. It is easy to see that Toyota and the remarkable 7FB are ready to bring your business to new heights.



**Solid
Stability**

**Built-in
Efficiency**

**Productivity
PLUS**

**Environmental
Challenge**

Solid Stability for Travel & Load Handling

At Toyota, safety is the top priority and the 7FB is designed for high-level safety in the workplace. Toyota's unique System of Active Stability (SAS) and Operator Presence Sensing System (OPS) help to protect both the operator and the goods being handled. Toyota's continuous efforts toward safety provide you with a solid foundation for active operations.

SAS + OPS

System of Active Stability Operator Presence Sensing

Active Control Rear Stabilizer SAS OPT

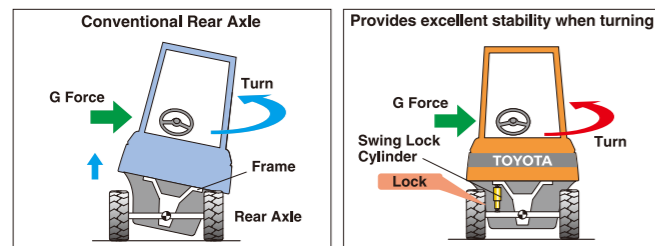

An onboard computer monitors the movement of the forklift and locks the swing of the rear axle when necessary, such as during turns.

Note: The Active Control Rear Stabilizer is not installed if the forklift is originally equipped with optional dual front tires.

Active Steering Synchronizer SAS OPT

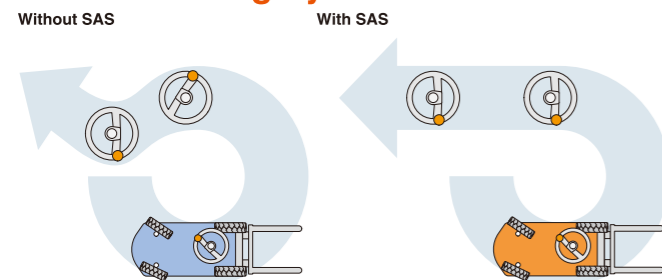

This function ensures that the position of the steering wheel unvaryingly corresponds with the position of the rear steer wheels.

Active Mast Function Controller SAS OPT



Active Mast Front Tilt Angle Control
Forward mast tilt is automatically restricted when heavy loads are being handled at high mast heights.

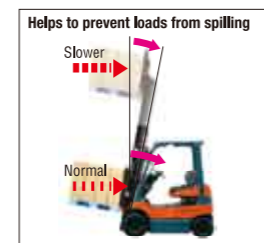

Active Mast Rear Tilt Speed Control
Rear tilt speed is controlled in relation to mast height. Mast tilt is slowed for better control at high mast heights and allowed to operate at regular speed when loads are closer to the ground.

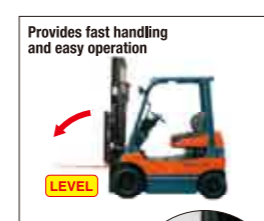

Automatic Fork Leveling Control
Level fork position provides easier fork insertion and extraction, helping to boost overall productivity. Simply press a button on the tilt lever when moving the mast from the rear-tilt position and the forks will automatically stop at the level position.

Operator Presence Sensing System OPS

This system uses a switch sensor built into the operator's seat to detect the presence of the operator. If the operator is not in the normal operating position, travel power is interrupted and load handling operations are stopped to prevent unintentional movement.

Note: OPS does not operate the brakes. Always set the parking brake before leaving the forklift.

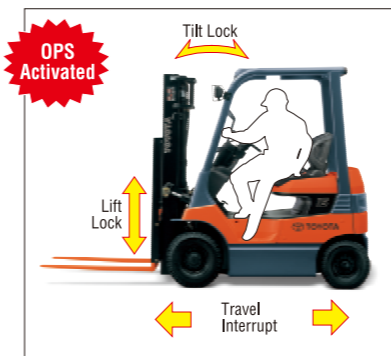

Built-in Efficiency Ready for Your Operations

Not only does the AC Power System provide the 7FB Series with the same level of performance as similar-size engine-powered forklifts, it gives Toyota engineers more design freedom than they ever had before. Smaller components allowed the battery to be repositioned to create a large open area and lower step for the operator's comfort. And, newly added features enhance both efficiency and comfort.



AC Power System

Multiple benefits of the AC Power System include: fast response to operating commands, precise power control, compact components. Moreover, since the AC motor does not use contactors and brushes, maintenance of these items will no longer be required.

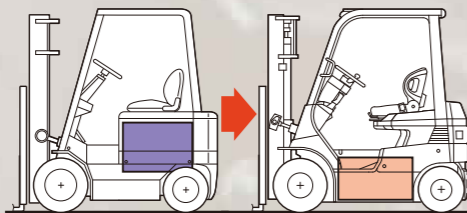

Battery Layout

Powerful yet compact AC motors allow the battery to finally move from under the operator's seat to under floor.



Expanded Leg Space

Designed to provide plenty of space to enhance the operator's comfort and reduce fatigue.

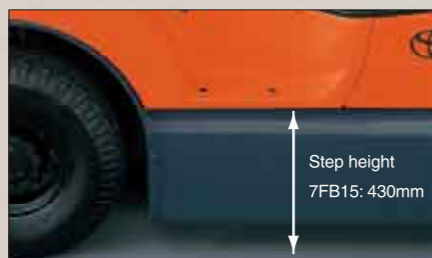

Low-Height Step

Easy entry and exit thanks to the strategically located battery. This will be much appreciated by operators who have to get on and off of the forklift frequently.



Large Assist Grip **New**

The assist grip is the first part the operator touches when entering the forklift.

The large assist grip, designed to meet the needs of varying operator sizes, supports smooth entry and exit.



Angled Lower Stay of the Backrest **New**

Optimizing the angle of the lower stay on the backrest provides you a clear view of fork tips, which makes it easier to insert forks to the pallet on the ground.



ORS Seat

Operator Restraint System (ORS) seat contributes to comfort and security. Side wings and a retractable seat belt help keep the operator in place. The ORS seat can be adjusted longitudinally 150 mm. Its durable seamless covering resists tears and repels water.



Tilt Steering with Memory Device

Tailors the forklift to the operator. Adjusts to any position within a 13 degree range. The steering wheel tilts out of the way to accommodate battery changes, but can be automatically returned to its previous position.

Productivity PLUS Options for Specific Needs

With Productivity PLUS options, Toyota offers specialized solutions for your operational needs. These options represent the culmination of years of customer feedback on what they needed to do work more efficiently. The Productivity PLUS options can offer the solution to your specific needs.



Battery Side-Out **New** OPT

With the forks pockets under a battery case, you can have an access to the battery from a side of the forklift. This option will make your battery change operation quicker and easier.

Note1: 7FBH (High capacity model) frame is used.

Note2: Underclearance is 15mm lower than standard specification.

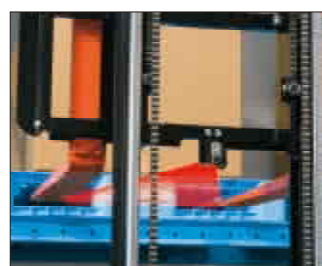

Laser Marker **New** OPT

A red beam will point out your forks' height to the goods. This option will support your operation especially in higher position.



Rear Pillar Assist Grip **New** OPT

A rear-pillar assist grip enhances comfort while traveling in reverse. A horn button on the grip supports your backward operation.



Fork Vibration Damper **New** OPT

An accumulator in the lift cylinder hydraulic circuit absorbs the shocks and vibration to the loads while traveling an uneven surface.

Digital Multifunction Display **OPT**

The status of key operational information such as speed and battery charge can be easily monitored with the Digital Multifunction Display. It is also be used to tune the power or speed. A diagnostic function is included.

Power Select Function

Customizes forklift performance to workplace needs. Both travel and load handling performance can be fine-tuned to match the conditions in the workplace and the skill of the operator.

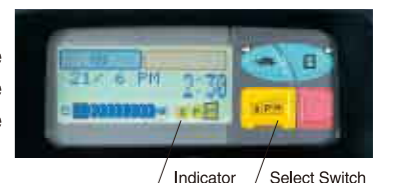

Indicator / Select Switch

Power Keep Function

Boosts performance when the battery charge is low. This control extends the efficient operating time of the forklift. Now the forklift can continue to work at top efficiency even when the battery charge is getting low.

Note: Does not function in H-mode.

Battery Discharge Level and Performance Level

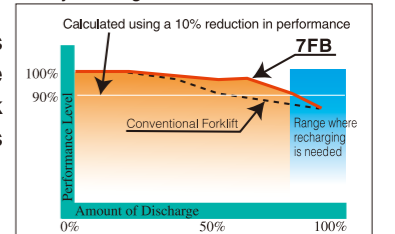

With Load Meter **New** OPT

A digital load weight meter can be added to the Digital Multifunction Display. The display will show you the approximate weight of the goods when you release the lift lever.

Note: The indicated figures are not for commercial use.



The Toyota Environmental Challenge

Getting the job done with minimum impact on our environment is a challenge Toyota takes very seriously. The 7FB demonstrates this commitment. Toyota raises the bar for performance and environmental responsibility in the materials handling industry.

The 7FB is just one of a wide line-up of products that underscore Toyota's commitment to our environment.

Zero Exhaust Emissions

Electric forklifts are innately environmentally friendly. They emit zero exhaust emissions during operations. The 7FB helps create a clean workplace and contribute to cleaner environment.

Regenerative Braking System for Saving Energys

The regenerative braking system – which uses the electric motor as a generator – together with the AC Power System help extend operating time per charge. The regenerative braking system operates when the accelerator is released, during switch back or during braking. This system also helps slow the forklift naturally when the accelerator is released. The 7FB is dedicated to saving energy and helping our environment.

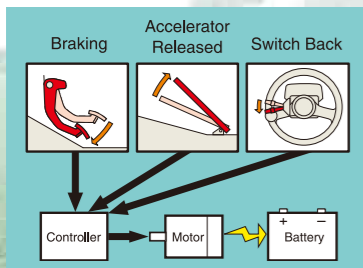

The 7FB is produced in a certified ISO14001 factory, the Takahama Plant, ensuring minimum impact on the environment. Toyota suppliers are also required to meet this stringent international standard.

Toyota operates under a global charter for environmental responsibility that covers all aspects of a vehicle's life cycle, from a waste-free production process and cleaner operation all the way through to effective end-of-service-life recycling.



Toyota Takahama Plant :Japan



ISO 14001
JAER 0066