

## Introduction

Welcome to your **optimus** sound level meter. This next-generation instrument from Cirrus Research plc is powerful yet simple to use, and is capable of a wide range of noise measurement functions.

The advanced technology used in the **optimus** instruments does not get in the way of you making effective noise measurements, and the large, clear screen makes it easy to read the comprehensive information on the display.

The **optimus** makes your noise measurements simple:

### **Measure everything and forget nothing**

One of the key aims of the **optimus** instruments is to give you a sound level meter that is as simple to use as possible whilst providing the very highest level of performance and function.

You cannot forget to measure the right function as everything is measured at the same time.

For example, if you've chosen the Fast time weighting View Option, the **optimus** will still measure Slow and Impulse at the same time.

You can choose another time weighting View Option from the menu, and then see real-time data or review stored measurements using the new parameters.

This applies to all other noise parameters (excluding Dose - for further details, see page 25).

The **optimus** measures them all, and you can choose your View Option to review the data.

### **VoiceTag audio recording**

The data logging versions of the **optimus** feature the VoiceTag audio recording function.





This allows you to record notes and information before a measurement by simply speaking into the microphone, then play them back later in the NoiseTools software.

You can save time when making measurements, and remove the need to carry a notepad and store any important information about your measurements.

### **A single measurement range**

By using the very latest in digital technology combined with 40 years' experience in designing sound level meters, we have given the **optimus** instruments the ability to measure from 20dB(A) to 140dB(A) and up to 143dB(C) Peak in a single span.

This means that there is no need for you to choose which range you may need for your measurement, and that there is almost no chance of the instrument overloading or under-ranging.

### **A clear, simple display of the information you need**

The display used on the **optimus** is a high resolution colour OLED type. This gives a clear, bright display that is easy to read in all light conditions as well as allowing us to use colour to show specific functions and information.

All of the information that you need is shown clearly on the screen with the most useful function, for example the Leq in the Leq View, shown in large white text. This makes it easy for you to see the information that is important at a glance.

### **A modular design to future proof your investment**

The **optimus** instruments are based around a modular design which allows you to upgrade and update your instrument if and when the time arises.

This means that your instrument will meet your current and future needs, no matter what you need to measure.

### **Audio Recording during measurements**

The **optimus** green instruments can record and store audio data (the actual sounds heard by the microphone) during a measurement.

This data can be downloaded along with the noise measurements for analysis and review and can be used to identify the source of the noise.

Audio recordings can be started either manually or automatically using a set of triggering rules.

## **First Use**

Your **optimus** sound level meter has been shipped in reusable packaging that should be retained for safe shipment when returning the instrument for calibration or servicing.

All **optimus** meters come with the following standard accessories:

- MV:200 Microphone Preamplifier
- Microphone capsule (attached to the preamplifier)
- Wrist
- 4 x AA batteries
- User Manual
- Product CD (with NoiseTools software and documentation)
- Windshield

You may have other accessories, depending on your package. Please check for damage or missing items before using your **optimus**.



All **optimus** instruments are shipped with the removable preamplifier separated from the body. When connecting the preamplifier, please take great care to only turn the locking ring at the base.

Twisting the preamplifier body is likely to cause serious damage. The microphone capsule is also delicate, and care needs to be taken when handling.

Damage caused by misuse is not covered by the warranty for the instrument.

To connect or remove the preamplifier, please follow the diagram:

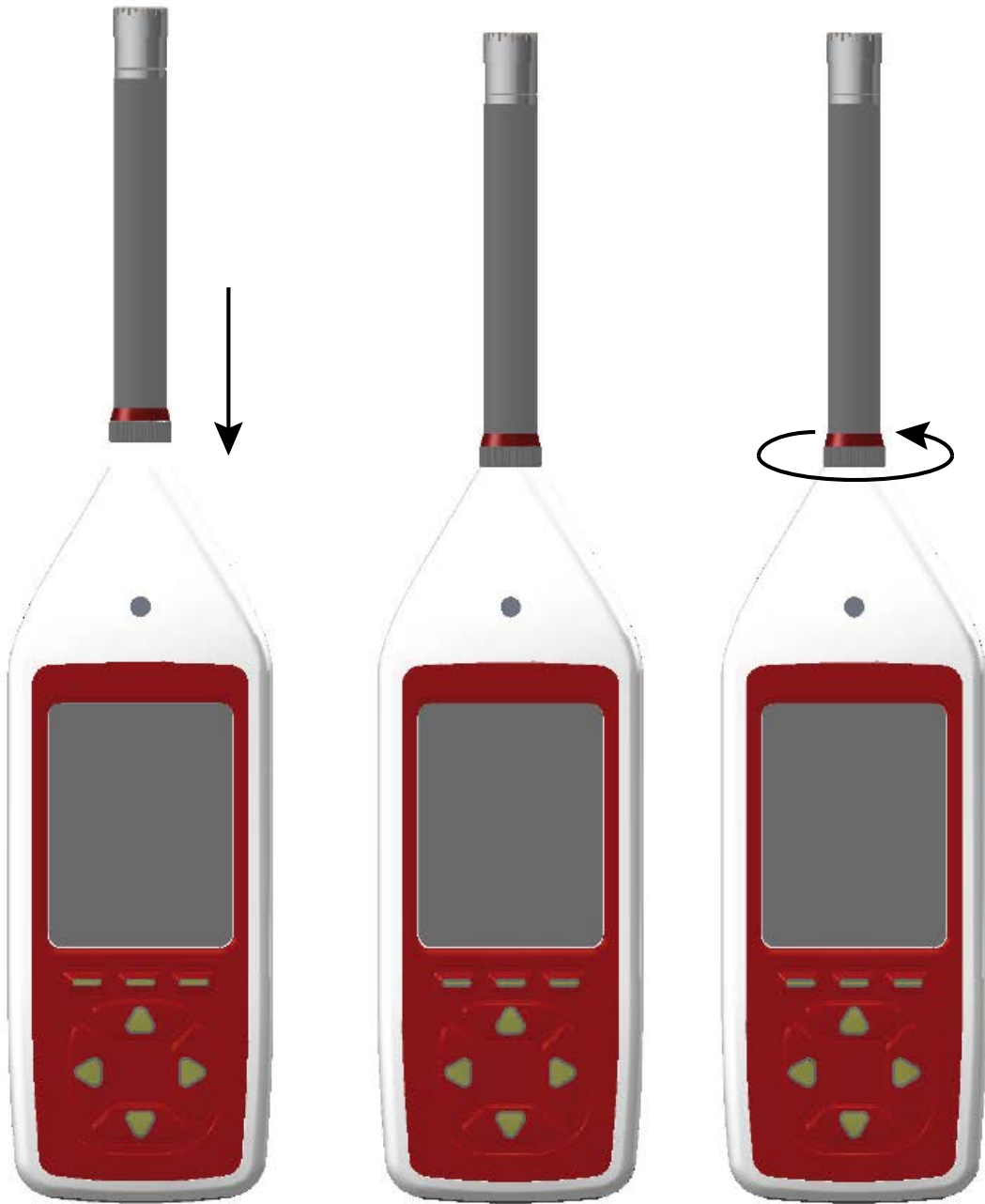

### Inserting the batteries

Your **optimus** is powered by 4 x AA batteries (also called MN1500 or LR6). We recommend that you use alkaline or lithium batteries to give the best performance.

Remove the battery cover by loosening the captive locking screw (as shown below).

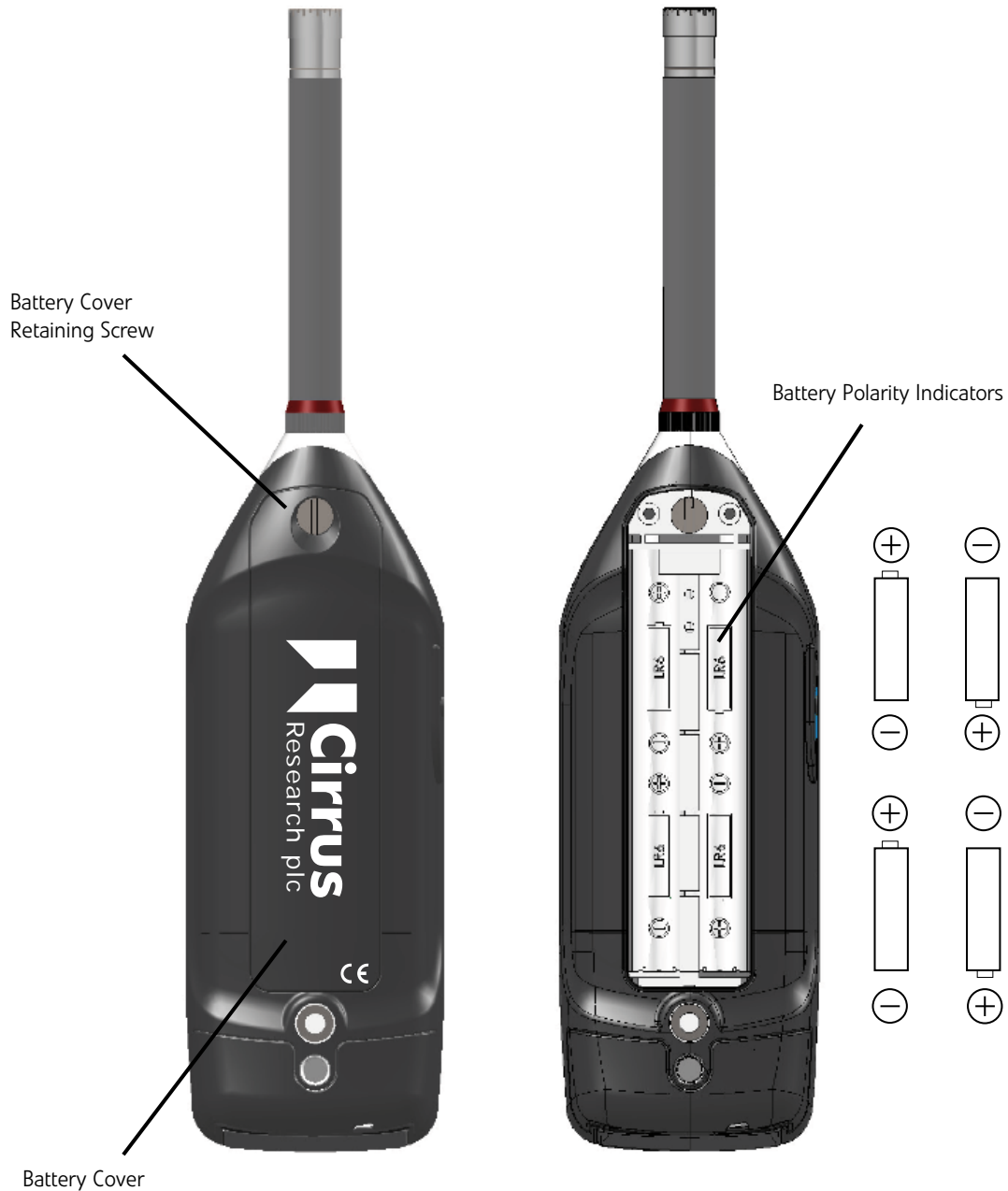

Please look carefully at the diagram inside the battery compartment showing the correct polarity. After inserting the batteries in the correct orientation, replace the cover and tighten the locking screw.

The instrument is switched on by pressing and releasing the power button on the left hand side of the case. After the boot screen, your **optimus** will display the last View you used.

### **Calibration**

All noise measuring instruments should be calibrated before each use, because the microphone is susceptible to minor damage from even small knocks.

The calibration applies corrections (if needed) to ensure that your measurements are as accurate as possible.

Calibration should also be carried out at the end of a measurement session to make sure that nothing has happened to the instrument during the session.

To calibrate your **optimus**, carefully push the microphone into the cavity at the end of the calibrator. Ensure the microphone is fully inserted into the cavity and is past the 'O' ring seals.

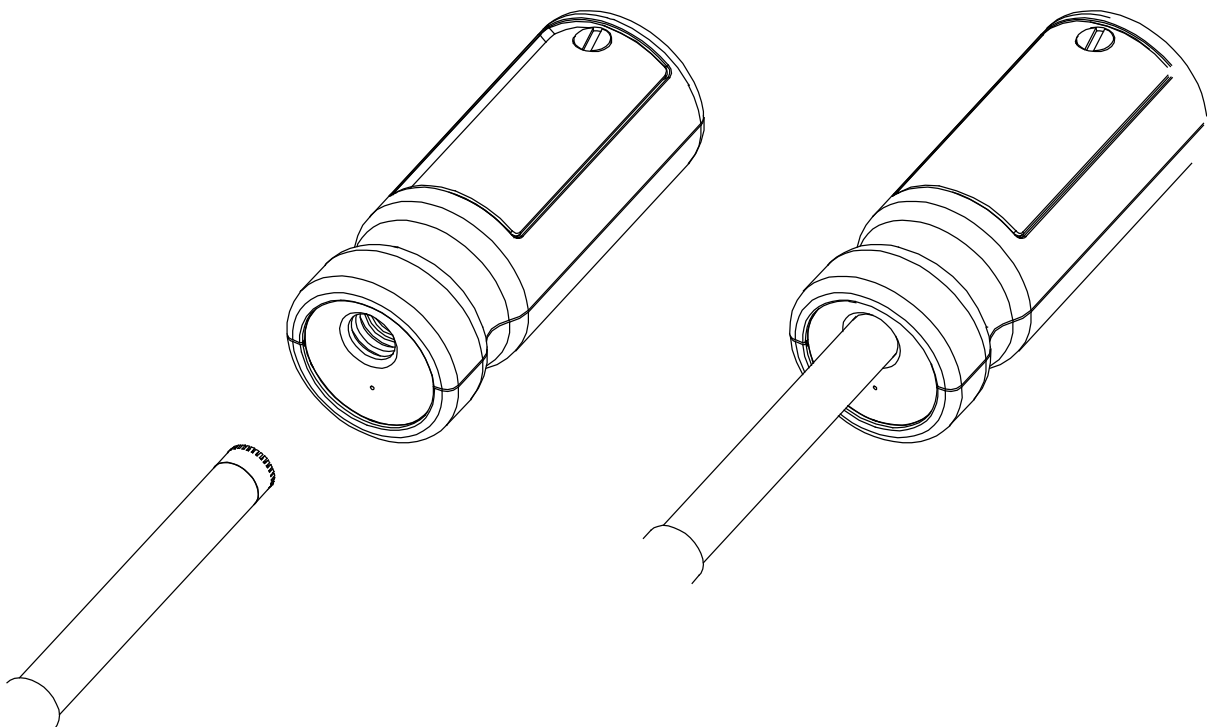

Ensure that the small bleed hole next to the microphone cavity on the calibrator is not blocked, as this could cause damage to the microphone.



Take care not to use a twisting motion when pushing the microphone into the calibrator, as this is likely to cause damage to the preamplifier (as described earlier in this chapter).

Press the 'on' button on the end of the calibrator. Press the calibrate button on the **optimus**.

The instrument will measure the sound level from the acoustic calibrator to determine if it is within the required tolerance and levels. The calibration level must be stable to within  $\pm 0.075\text{dB}$  for 5 consecutive seconds for the calibration to be successful.

When the calibration is completed, the **optimus** will display the level along with the correction or adjustment made.

The **optimus** is preset with the correction values needed for Cirrus Research microphone capsules, so no manual adjustment is required. The calibration level you should expect is 93.7dB.

Refer to page 40 for detailed operating information for the CR:514 and CR:515 Acoustic Calibrators.

## **Making a measurement**

Press the Start key to begin recording (on data logging instruments with the VoiceTag function switched on, the VoiceTag screen will show – press skip to move on without recording a note).

Your **optimus** is now measuring and recording noise data for all available functions, regardless of your selected View, and the red animated Running icon will show in the top left of the information bar.

The measurement can be paused by pressing the Pause/Stop soft key .

Press once to pause/back erase and twice to stop, or alternatively press and hold for three seconds to stop. (For Pause & Back Erase, see page 21).

The Pause/Back Erase function is only available if this has been enabled in the instrument menu.

To stop the measurement, press the Stop key. The instrument will change from measurement to review mode, and your data is stored and ready to review and download. For instruments without data logging, only the last recorded measurement is available for review.

## Operations in more detail



Please note: from this chapter on, the manual describes capabilities which are available on different models within the **optimus** range.

If you are unsure which capabilities your **optimus** has, you can check on the instrument by looking at the General View / page 5 (and 6 on some models), or look at the Features Matrix available on the Cirrus Research website: [www.cirrusresearch.co.uk/optimus/library](http://www.cirrusresearch.co.uk/optimus/library)

## NoiseTools

All **optimus** instruments are delivered with a copy of the NoiseTools software which can be used to configure the instrument (some options are only configurable within NoiseTools and not on the instrument – it will be made clear in the text where this is the case).

NoiseTools is also a powerful environment for storing, analysing and organising your data, and produces reports for publication. VoiceTag notes and audio recordings can only be played back through NoiseTools.

## Keypad and Controls

The **optimus** is controlled via the four arrow keys (up, down, left and right) and three soft keys, which change in function depending upon the mode that the instrument is in. The soft key function is shown above the button on the display.

The left and right keys move between the Views and the up and down keys move between the pages of each View.

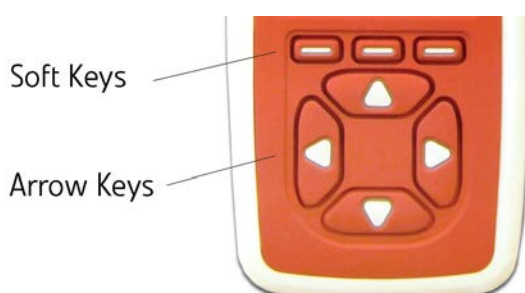

The ambient light sensor on the front of the instrument will illuminate the keypad and adjust the brightness of the display automatically when the light level falls.

When the pause function has been activated (described on page 27), the right soft key toggles between pause and stop. Press once to pause/back erase and twice to stop, or alternatively press and hold for three seconds to stop.



## Connectors

The connectors used by the **optimus** to communicate with a PC and NoiseTools are at the bottom of the instrument under a protective cover.

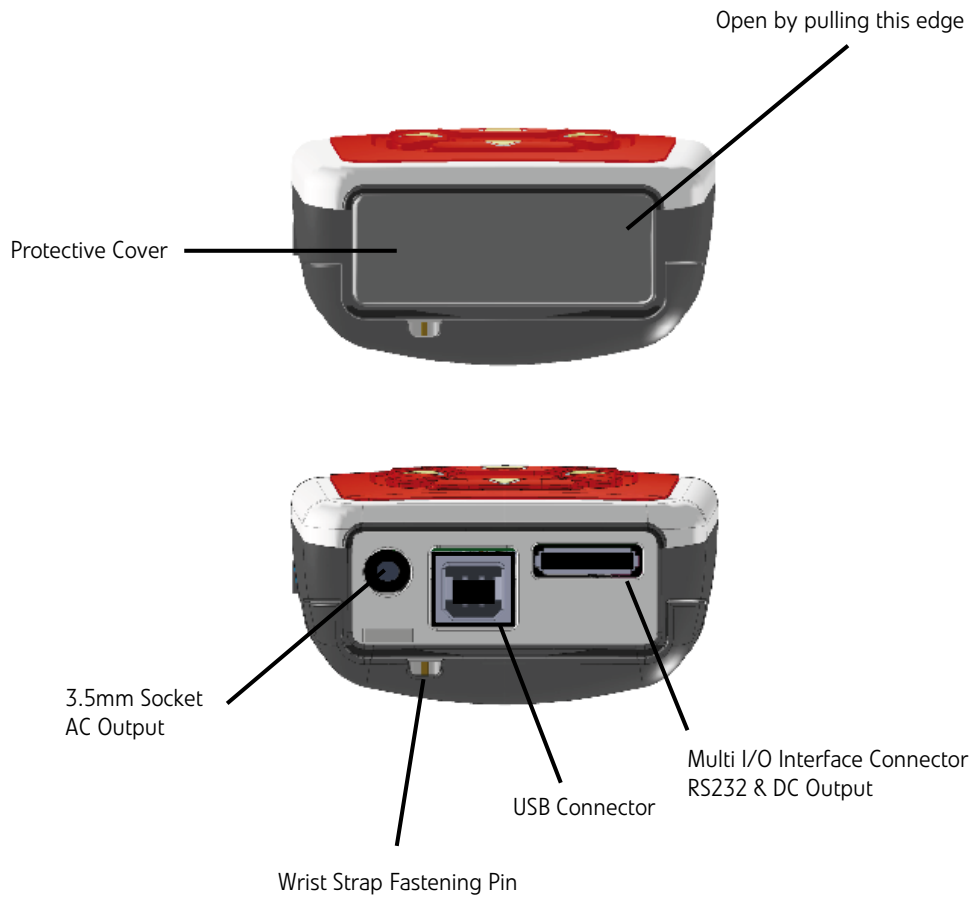

The **optimus** can be powered via the multi-pin connector on the bottom of the instrument. Power can be connected using a ZL:171 **optimus** power input cable (2.1mm Power Jack, 2m) or via ZL:176 **optimus** 12v Battery pack cable.

The **optimus** can also be powered from an external source, such as a USB connection to a PC or via a USB power supply.

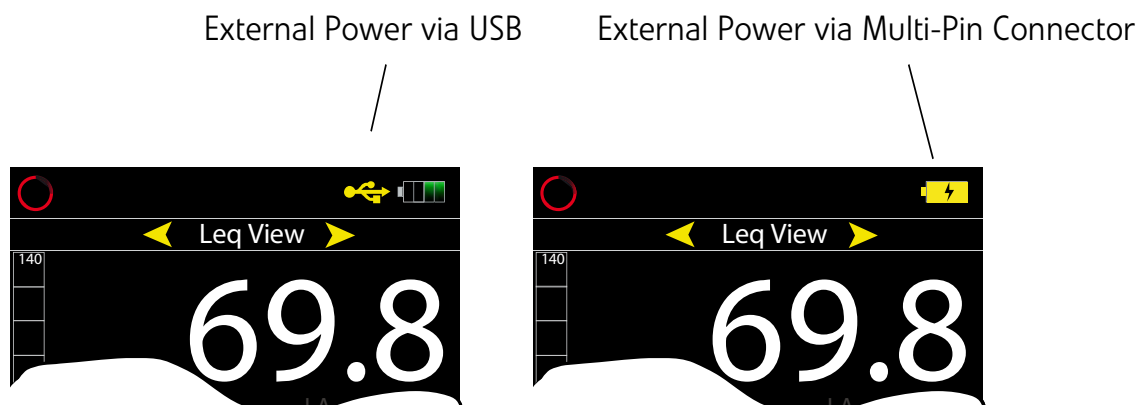

An AC output is available on the **optimus** via the 3.5mm jack socket. The output is un-weighted and the output level can be adjusted using the options in the AC Out menu.

This output can be used with external instrumentation. See page 37 for details of the electrical outputs.

### Screen saver

If no keys are pressed for 6 minutes the display will dim to preserve battery and screen life, and reduce power consumption. After 30 minutes with no key presses the display will switch off completely and keypad flashes every two seconds to show that the instrument is powered. The screen dim and screen saver functions will occur during measurements as well as when not measuring. Press any key to restore the display.

The time intervals for the screen dim and screen saver are configurable in NoiseTools.

### Display

The **optimus** uses a high resolution colour OLED screen to show a clear and easy to read display of all the information you need.

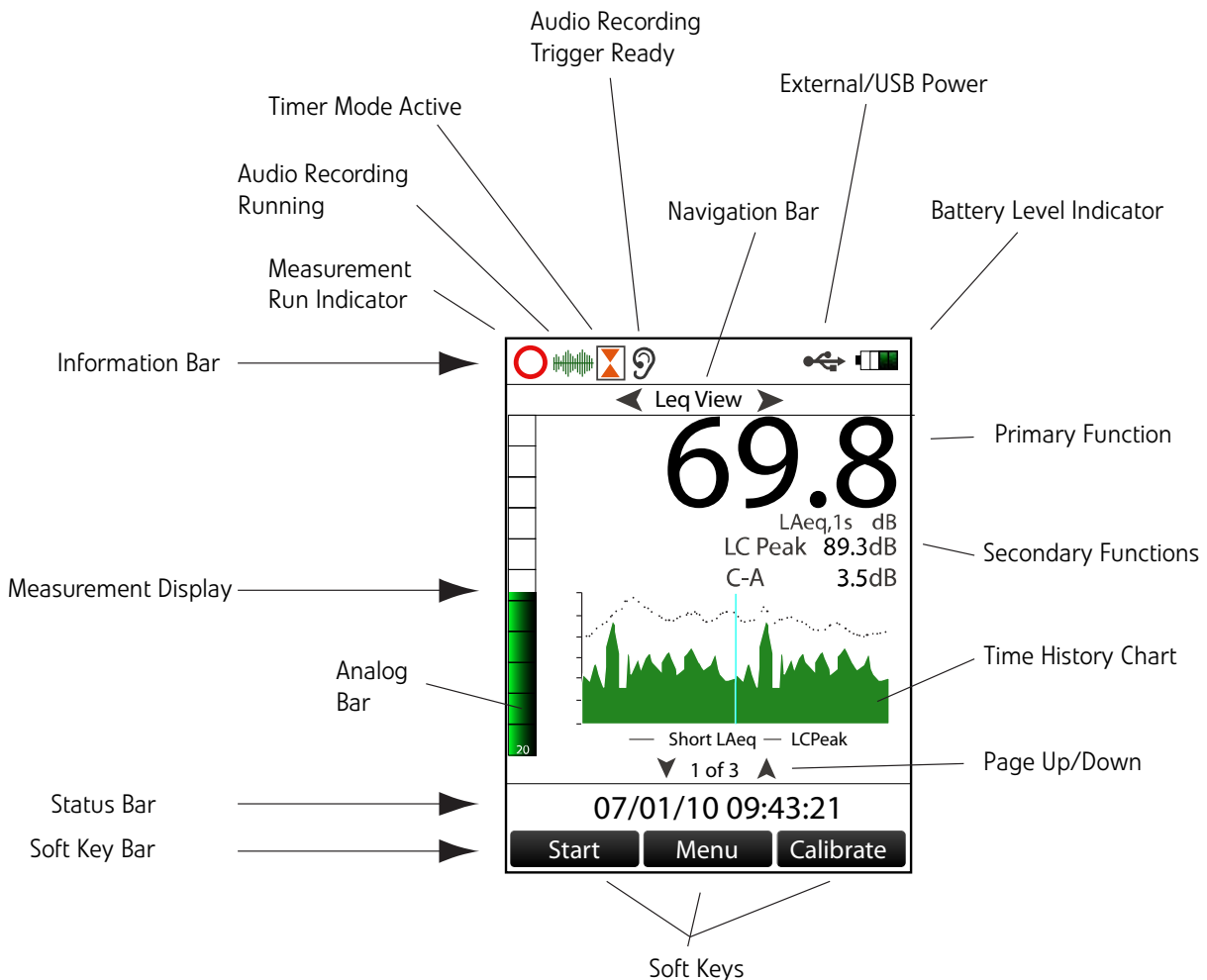

### Information Bar

The information bar shows icons when functions are active. Examples of the icons are shown in the diagram above.

### Navigation Bar

The navigation bar shows which View or Menu you are looking at.

### Measurement Display

In addition to primary and secondary functions, the display features an Analog Bar on the left of the screen, which shows real time A-weighted sound level. At the bottom of the screen is the Page information for your View, ie 1 of 3.

### Status Bar

When the **optimus** is not measuring, the status bar shows the date and time. When it is measuring, the display shows the elapsed time and in Review mode it shows the measurement number and the total number of measurements stored.

### Overload and Under-Range Indication

Overload is indicated by the word 'overload' and Under-Range is indicated by the word 'under range' (in the chosen language) on the display.

On the Sound Level View and Leq View the indicators are situated beneath and to the left of the large number. When a measurement is not in progress, the indicator is shown for at least 1 second, so that very short transient overload or under-range conditions are visible to the operator.

When a measurement is in progress, the overload indicator stays on until the measurement is stopped or reset.

In some circumstances the overload and under range indicators will be shown simultaneously. In this case the text will be abbreviated to save space.

Note that if any displayed decibel value on the Sound Level View or Leq View is below 14.0dB, the value will be replaced by dashes ('---'). These levels are typically below the noise floor of the microphone capsule and so will only be encountered during electrical testing.

### 'Bluescreen'

Under rare circumstances, when the **optimus** encounters a condition it cannot recover from, a 'bluescreen' error message will show with an error code. If this should happen to your **optimus**, please make a note of the code so the engineers at Cirrus Research

can diagnose your problem accurately. After writing down the code, pressing the right key will clear the screen and the instrument can be used as normal.

### **Battery indicator**

The status of the batteries is shown in the Battery Level Indicator. When the batteries need replacing, the indicator will turn red.

### **Low Battery Indication while switching on**

If the start-up screen flashes quickly when you press the on button, the batteries have insufficient power to start and need changing.

### **Audio Recording**

Audio recording can be started automatically using the Audio Triggers or manually using the Audio soft key.

This starts the **optimus** recording raw WAV data at a quality which can be set in the Menu (Standard or Studio).

Details of the Audio Triggers can be found in **Technical Note 28 - Audio Recording with the optimus green sound level meters**. Please refer to the Cirrus Research plc website at [www.cirrusresearch.co.uk/library/optimus](http://www.cirrusresearch.co.uk/library/optimus).

Pressing the audio key again stops the recording. There is no maximum duration of an audio recording set by default, but it can be changed in NoiseTools, and the parameters for the Audio Triggers can be configured in NoiseTools.

The audio recording includes a 10 second back buffer (on the Standard quality setting). When triggering a recording manually, it's very difficult to record the beginning of a sound that catches your attention.

The back buffer will cover the time it takes you to respond and press 'record'. 10 seconds is the default duration, which can be changed in NoiseTools.

The Time History display and Analog bar turn **blue** when audio recording is running and revert to **green** when it is stopped.

Starting and stopping audio recording during a measurement does not affect the noise measurement data being recorded.

Please note, VoiceTags are recorded BEFORE the measurement starts and are for spoken notes only, not for analysis of recorded sounds.

## **Timers**

The single and repeat timers allow you to make precisely timed measurements over pre-set or custom defined durations, which are set on the instrument using the Storage Options Menu (see next chapter).

The repeat timer allows measurements to be stopped and started automatically over a long period of time. The **optimus** can still be stopped and started manually when the repeat timer is active.

The repeat timer is synchronised to the real time clock, so if you choose a 30 minute duration the measurement will begin on the hour or at 30 minutes past. When the measurement ends, a new one will begin and last for the next 30 minute interval.

If the **optimus** is paused when an automatic timer begins, the new timed measurement will also be paused.

Please note, after 5 minutes in pause the **optimus** will restart.

## **Back Erase/Pause**

### **Pause**

The **optimus** sound level meters provide Pause and Back Erase function which can be used during a measurement.

When the Pause function is enabled in the menu, the Stop button is replaced by the Pause/Stop button. This also enables the Back Erase function, the duration of which can be set in the menu.

### **Back Erase**

The Back Erase function allows a section of the measurement to be removed from the data used to calculate the overall values.

An example of this would be if, during the measurement of cars on a road, a large truck passed by the measurement location. If the intention was only to measure cars, the truck can be excluded from the overall measurement data by pressing the Pause button and then using the Back Erase to remove a preset section of noise.

The time that the pause button was pressed, along with the Back Erase duration, will be excluded from the calculation of the overall noise values such as the Leq, Lmin, Lmax, LPeak, and the 1:1 and 1:3 Octave Band overall values.

The duration of the Back Erase can be set to between 1 and 30 seconds using the menu and can also be configured in the NoiseTools software. If the Pause function is disabled, the Back Erase function is also disabled.

### **Memory**

The **optimus** has a 4GB memory as standard. This is partitioned into two sections, one to record time history and one for audio (VoiceTags and audio recordings). The space allocated to each can be configured in NoiseTools.

The free space in the memory is shown in the General View as days or hours available for both time history and audio. When either partition is full, the **optimus** will overwrite the oldest data in that partition.

To clear the memory and permanently delete all stored data, choose the 'Clear Memory' Menu page and follow the instructions on screen. Before permanently erasing the data, you will be asked to press 'OK' to confirm.

### **Restore Factory Settings**

This is in the Advanced Options Menu, and restores the **optimus** to the default options for all user-definable settings in the Menus, and clears the calibration offset. For settings such as 'language' where there is no default, the **optimus** will return to the option it was shipped with.

Follow the instructions on the screen, and press 'OK' to confirm.

This does not delete any stored measurements.

### **Windshield**

The **optimus** can be used with a UA:237 90mm foam windshield which will reduce the noise levels generated by air turbulence over the microphone capsule.

It can also help protect the microphone capsule from dust and fluids which can affect the performance of the instrument.

## Getting to know your **optimus** – features and capabilities

The **optimus** instruments are designed around a modular structure that allows an instrument to be upgraded and updated with new capabilities (functions), protecting your investment for the future.

To check which capabilities your **optimus** has, go to General View / page 5 (and 6 on some models). This will list all the available capabilities. Alternatively, a Feature Matrix is available on the Cirrus Research website, which lists all the capabilities for all **optimus** models.

Some options cannot be changed while the **optimus** is measuring, and a message will appear on the screen telling you 'cannot be changed while measuring'. Some menu choices are disabled while measuring, and will appear grey on the screen.

### Views

The views are accessed by pressing the left and right control keys. The views are available when the **optimus** is measuring, not measuring or in review mode, but the pages available in each mode will differ.

#### **Not measuring**

When not measuring, the information shown is live, instantaneous values.

#### **Measuring**

When measuring, these live values are still shown, but you are also shown cumulative overall values for the current measurement period.

#### **Review Mode**

In review mode, the values shown are the overall cumulative values for the measurement.

### **General View**

This shows the status of the instrument with the calibration data, the capabilities that are fitted, serial numbers of the instrument, microphone and preamplifier along with details of the standards that the instrument meets.

### **Sound Level View**

This view shows the Sound Pressure Level or SPL, with the maximum and minimum sound level (Lmax and Lmin) with a choice of A, C and Z frequency weightings.

## **Leq View**

Shows you the Leq, Peak, LAE (SEL) and C-A values with a choice of A, C and Z frequency weightings.

The C-A data can be used with the HML method for selecting hearing protection.

If the Time Weighting is set to Impulse, the C-A function is replaced by LAeq,I (also known as LAeq).

When the instrument is set to the German language, an additional 'Taktmaximal' page is also available.

## **1:1 Octave Band View**

This view shows the noise levels divided into Octave frequency bands. This can be used to aid in the selection of hearing protection and also for noise control applications.

Some models also have the capability to show NR & NC Curves and resultant values.

## **1:3 Octave Band View**

This view shows the noise levels divided into 1:3 Octave (called 'third-octave') frequency bands. This can be used for environmental noise measurements and also for noise control applications.

The 1:3 Octave Band View also provides Leq LF (20Hz-200Hz) and LAeq LF (20Hz-200Hz).

## **Tone detection**

This is a capability on some instruments, displayed within the 1:3 octave view.

Instruments with Tone Detection use either the ISO 1996-2:2007 Simplified Method or an improved method developed by Cirrus Research which is based upon the ISO standard, extended to include tones between bands, tones in outer bands and Z-weighting. The ISO method only applies to overall data when measuring or reviewing, whereas the Cirrus Improved Method also applies to instantaneous live values.

When a tone is detected, the band is highlighted in blue on both the graphical and numerical pages.

This can be set to the Cirrus Improved Method (default setting) or the ISO 1996 method in NoiseTools.



For more information, please see **Technical Note 32 - Tonal noise detection with the optimus sound level meters** available for download from the Cirrus Research website at [www.cirrusresearch.co.uk/library/optimus](http://www.cirrusresearch.co.uk/library/optimus).

### **Ln View**

The Ln view shows the statistical Ln values calculated during the measurement. The first seven Ln values are set by default to commonly used values and 8-14 are definable in NoiseTools.

Some **optimus** models have a second set which are also 1-7 default, 8-14 user definable.

The source data type for the second Ln set is also configurable in NoiseTools.

### **Dose View**

The Dose View gives you a number of different functions depending upon the configuration of the Quick Settings.

For the UK option, this View gives you Leq, LEP,d, % Dose and Estimated Dose along with the Projected Exposure Calculator.

For the EU option, this View gives you Leq, LEX,8, % Dose and Estimated Dose along with the Projected Exposure Calculator.

For all other options the Lavg, TWA, % Dose and Estimated % Dose for two integrators, in addition to ISO (EU), will be shown according to the setting you have chosen.

Two custom integrators can also be used, configured in NoiseTools. When chosen, they will be shown in addition to ISO (EU).

### **Moving Average View**

The Moving Average View is available on the CR:191BE & CR:193BE instruments only.

The Moving Average View shows a 15 minute and 60 minute moving average LAeq along with LASmax and LA95 values.

The LAeq values are highlighted in colours under certain conditions. See page 25 for details of the trigger levels.

### **High Level Noise Measurement**

The **optimus** sound level meters can be used to measure high noise levels (up to 170dB) with the use of the optional MV:200EH High Level Noise Measurement Option.



















### Moving Average View

- Page 1
- LAeq,15min
  - Indicated in Red where LAeq,15min > 95dB,
  - Indicated in Yellow where LAeq,15min > 85 dB
  - Indicated in White where LAeq,15min < 85dB
- LASMax
- LA95
  
- Page 2
- LAeq,60min
  - Indicated in Red where LAeq,60min > 100dB
  - Indicated in White where LAeq,60min < 100dB
- LASMax
- LA95















The microphone should be parallel to the body of the calibrator. Also ensure that the small bleed-hole next to the microphone cavity is not blocked as this could cause damage to the microphone.

Your **optimus** sound level meter will automatically make adjustments for the level produced by the acoustic calibrator and the microphone type fitted to the instrument.

### **Background Noise**

In order for the calibrator to operate as intended, the ambient acoustic noise level should be no greater than 80dBA.

### **Stabilisation**

In order for the sound pressure level and frequency to stabilise after switching the calibrator on when coupled to a microphone, a period of at least 3 seconds should be allowed before performing a calibration.

### **Changing the Battery**

The CR:514 & CR:515 acoustic calibrators use a single 9v alkaline battery. This type of battery is known as 6F22 or NEDA 1604. It is also commonly known as PP3.

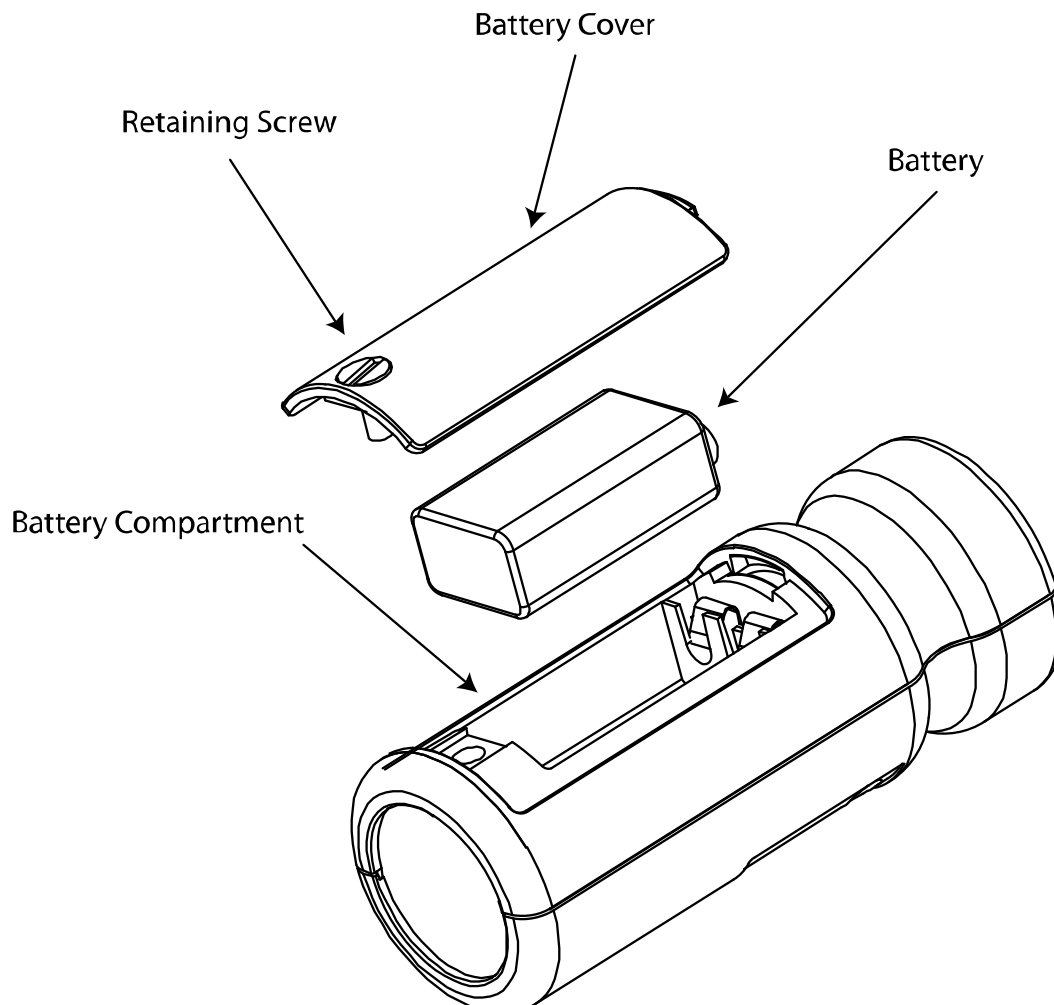

1. Unscrew the screw holding the battery cover on, using a coin or the keyring provided
2. The battery, type 6F22 (PP3) can now be eased out of its holder and replaced. The battery should be eased out terminal side first by pushing against the spring at the other end.

Ensure that the battery is inserted with the correct polarity with the negative terminal at the contact with the larger cut out.

### **Battery type**

The battery should be an alkaline battery, not an ordinary dry cell. The battery is 9 volts when new and will operate the calibrator down to 6.4 volts.

When the battery voltage is below 6.6 volts but above 6.4 volts, the power LED will flash to indicate that the battery voltage is low. When the battery voltage is below 6.4 volts the calibrator will not turn on.

A discharged battery may allow switch-on but will soon drop in voltage and indicate low battery or switch off.

### **Specifications**

Frequency	1kHz $\pm$ 1%
Sound Level	94dB re 20 $\mu$ Pa
Standardisation	CR:514 - IEC 60942:2003 Class 2 CR:515 - IEC 60942:2003 Class 1
Distortion	Less than 2%
Operating Humidity	25 to 90% Relative Humidity
Operating Static Pressure	65 kPa to 108kPa
Operating Temperature	-10°C to +70°C
Storing Temperature	-20°C to +70°C
Effective Volume	6.19 cm <sup>3</sup> $\pm$ 0.2 cm <sup>3</sup>
Cavity Diameter	0.525 inch
Battery	1 x 9v 6F22 (Neda 1604)
Battery Life	Approx 15 Hours Continuous Use
Battery Voltage	9v Nominal (10v Maximum, 6.4v Minimum)
Weight with Battery	185g
Dimensions	135mm x $\varnothing$ 48mm

### **Technical Information**

The normal mode of operation of the calibrator is with the unit switched on.

---

When the LED indicates the unit is switched on this produces the greatest radio frequency emissions.

The calibrator continues to function after exposure to contact discharges up to 4kV and air discharges up to 8kV, for both positive and negative voltages relative to earth ground. The calibrator conforms to IEC 60942:2003 for a modulated root-mean-square electromagnetic field strength of 10 V/m.

The maximum susceptibility to power and radio frequency fields is with the cavity facing away from the emitter with the battery compartment facing the table, the antenna polarisation horizontal and the calibrator switched on.

### Free Field Correction

When calibrating a microphone which is to be used for free field measurements, a small correction may be necessary to compensate for the difference between the microphone's free field response at 'zero degrees' or 'head-on' incidence and the pressure level generated by the calibrator.

The correction is typically -0.3dB for ½ inch microphones (making the effective calibration level 93.7dB).

Calibration corrections are listed below for the Cirrus Research plc ½" Capsules and three microphone capsules commonly used in Calibration Laboratories:

#### Microphone Correction Values

Microphone Type	Calibration Correction	Effective Calibration Level
MK:202	-0.3dB	93.7 dB
MK:215	-0.3dB	93.7 dB
MK:226	-0.3dB	93.7 dB
MK:224	-0.3dB	93.7 dB
B&K 4134	0dB	94.0 dB
B&K 4180	0dB	94.0 dB
B&K 4192	0dB	94.0 dB

#### Example

An example of the procedure used to calculate the value for an MK:224 microphone is shown below :

Level = 94.0dB + Microphone Correction

Level = 94.0dB + ( -0.3dB)

Level = 93.7dB

## CE Certificate of Conformity



### **Cirrus Research plc Hunmanby UK**

Manufacturer: Cirrus Research plc  
Acoustic House, Bridlington Road  
Hunmanby, North Yorkshire, YO14 0PH  
United Kingdom  
Telephone +44 1723 891655



### **Equipment Description**

The following equipment manufactured after 1st January 2012:

CR:151 Sound Level Meter (A & B Versions)  
CR:152 Sound Level Meter (A & B Versions)  
CR:161 Sound Level Meter (A, B, C & D Versions)  
CR:162 Sound Level Meter (A, B, C & D Versions)  
CR:171 Sound Level Meter (0, A, B & C Versions)  
CR:172 Sound Level Meter (0, A, B & C Versions)  
CR:19x Sound Level Meter (All versions)  
CR:514 Acoustic Calibrator  
CR:515 Acoustic Calibrator



Along with their standard accessories

According to EMC Directives 89/336/EEC and 93/98/EEC meet the following standards

Sound Level Meters IEC 61672-1:2002, IEC 61672-2:2003  
Acoustic Calibrators IEC 60942:2003

Except where modified by EN 61000-6-1:2007 & EN 61000-6-1:2007

EMC : Generic emission standard for residential, commercial and light industrial environments.

EN 61000-6-1 (2001)

EMC : Generic immunity standard for residential, commercial and light industrial environments.

A handwritten signature in black ink, appearing to read 'M Williams'.

Martin Williams  
Chief Engineer

Dated 25th March 2022

## **Warranty**

1. Every new product is provided with a 12-month no-quibble warranty. This covers everything we provide against failure, poor workmanship and accidental damage.
2. NB - European Union law states a product has to be fit for purpose for 24 months after purchase. This two-year period covers failure and poor workmanship only.
3. If the product is calibrated by Cirrus Research or an authorised calibration and service centre, then the initial 12-month warranty is extended by a further 12 months, with the same conditions, for up to 15 years in total.
4. If a product has not been calibrated annually by Cirrus Research or an authorised calibration and service centre, then you may buy back into the warranty scheme for a small fee, plus the cost of calibration. This can only be done once during the life of the product.
5. If a microphone capsule fails under warranty and is physically damaged, we will replace it with a refurbished capsule.
6. If you don't wish to have a refurbished capsule, then you can trade in your damaged capsule for a new one, which will incur a fee.

## Index

1:1 Octave Band .....	24	Frequency Weightings ..	31	<b>OSHA</b> .....	37
1:3 Octave Band .....	24, 36	High Level Noise		OSHA HC .....	28
AC Out.....	27	Measurement .....	25	Overload.....	19
AC Output .....	37	HML .....	24	Pause.....	21, 27
AC Output Cables.....	38	IEC 60651:2001.....	30	preamplifier .....	11
Advanced options .....	27	IEC 60804:2000.....	30	Quick Settings.....	28
ANSI S1.11.....	30	IEC 61252:1993.....	30	Quick Start .....	3
ANSI S1.25.....	30	IEC 61260.....	30	Range .....	31
ANSI S1.4.....	30	IEC 61672 test data.....	30	Repeat Timer .....	28
ANSI S1.43.....	30	IEC 61672-1:2002 .....	30	Restart .....	26
Audio Quality .....	27	Impulse .....	27	Restore Factory Settings	
Audio Recording .....	20	Information Bar .....	19	.....	22
Audio Triggers .....	27	Input & Output Cables ..	39	Review Stored data .....	26
AuditStore .....	31	ISO 1996-2:2007 .....	24	Screen Brightness.....	27
back buffer .....	20	Keypad .....	16	Screen saver .....	18
Back Erase.....	21	LAE.....	24	SEL.....	24
Background Noise.....	41	LAeq.....	32	Set Clock.....	28
batteries.....	12	LAeq,l.....	24, 32	Set level colours.....	27
Batteries.....	31	LAeqLF .....	33	Short LAeq.....	32
battery cover .....	12	LAeq.....	24	Single Timer.....	28
Battery indicator .....	20	LAeq,t .....	32	Size .....	31
C-A .....	24	Language.....	27, 31	Slow.....	27
Cables .....	38	LCeq.....	32	Sound Level .....	35
Calibration.....	13	LCPeak .....	32	Status Bar .....	19
CE44		Leq.....	35	Storage options .....	28
Clear Memory .....	26	LeqLF .....	33	Stored Measurements ..	35
Clock .....	28	Ln 36		Taktmaximal .....	24, 32
Connections.....	31	Low Battery .....	20	Threshold .....	37
Connectors.....	17	LxE .....	32	Time History Rate .....	28
Criterion Level.....	37	Lxeq.....	32	Time Weighting .....	27
date/time formats .....	27	LZPeak .....	32	Time Weightings.....	31
DC Output .....	38	Maximum.....	32	Timers.....	21
DC Output Cables.....	38	Measurement Display ...	19	Tone detection .....	24
Display .....	18	Memory .....	22, 31	Tripod Mount.....	31
Dose.....	33, 35	Microphone .....	30	TWA .....	33
Dose %.....	33	Microphone Extension		UK.....	37
Electrical Outputs.....	37	Cables.....	39	Under-Range .....	19
EMC.....	44	Minimum .....	32	USB .....	17
Environmental.....	31	<b>MSHA</b> .....	37	View options.....	27
Est Dose %.....	33	Navigation Bar .....	19	Views .....	23
EU37		NC .....	24	VoiceTag.8, 15, 16, 28, 31	
External Power .....	31	Noise Floor.....	31	Warranty.....	45
Fast .....	27	NoiseTools .....	16	Weight .....	31
Free Field Correction.....	43	NR .....	24	Windshield .....	22

## **Cirrus Research Offices**

The addresses given below are the Cirrus Research plc offices. Cirrus Research plc also have approved distributors and agents in many countries worldwide. For details of your local representative, please contact Cirrus Research plc at the address below. Contact details for Cirrus Research authorised distributors and agents are also available from the Internet Web site at the address shown below.

### **Main Office**

Cirrus Research plc  
Acoustic House  
Bridlington Road  
Hunmanby  
North Yorkshire  
United Kingdom  
YO14 0PH

Telephone: +44 (0)1723 891655

Fax: +44 (0)1723 891742

E-mail: [sales@cirrusresearch.co.uk](mailto:sales@cirrusresearch.co.uk)

Web Site: [www.cirrusresearch.co.uk](http://www.cirrusresearch.co.uk)

### **France**

Cirrus Research France S.A.S.  
40 Bis Avenue Gabriel Fauré  
09500 Mirepoix  
France

Tel: +33 5 61 67 40 01

Fax: +33 5 61 67 40 56

Email: [sales@cirrusresearch.fr](mailto:sales@cirrusresearch.fr)

Web: [www.cirrusresearch.fr](http://www.cirrusresearch.fr)

### **Germany**

Cirrus Research GmbH  
Arabella Center  
Lyoner Strasse 44 – 48  
D-60528 Frankfurt  
Germany

Tel: +49 (0)69 95932047

Fax: +49 (0)69 95932049

E-mail: [vertrieb@cirrusresearch.de](mailto:vertrieb@cirrusresearch.de)

Website: [www.cirrusresearch.de](http://www.cirrusresearch.de)