

314E CR Hydraulic Excavator Specifications

Engine

Engine Model	Cat C4.4 ACERT	
Gross Power – SAE J1995	71 kW	95 hp
Net Power – SAE J1349	67 kW	89 hp
Bore	105 mm	4.1 in
Stroke	127 mm	5.0 in
Displacement	4.4 L	270 in ³

Weight

Operating Weight	14 800 kg	32,600 lb
------------------	-----------	-----------

Hydraulic System

Main System – Maximum Flow (Total)	254 L/min	67 gal/min
Swing System – Maximum Flow	127 L/min	34 gal/min
Maximum Pressure – Equipment	30 500 kPa	4,420 psi
Maximum Pressure – Power Offset Boom (optional)	29 900 kPa	4,340 psi
Maximum Pressure – Travel	35 000 kPa	5,080 psi
Maximum Pressure – Swing	23 000 kPa	3,340 psi
Pilot System – Maximum Flow	21.9 L/min	4.8 gal/min
Pilot System – Maximum Pressure	4120 kPa	600 psi
Boom Cylinder – Bore	110 mm	4.3 in
Boom Cylinder – Stroke	1000 mm	39.4 in
Stick Cylinder – Bore	120 mm	4.7 in
Stick Cylinder – Stroke	1197 mm	47.1 in
Bucket Cylinder – Bore	100 mm	3.9 in
Bucket Cylinder – Stroke	939 mm	37.0 in

Drive

Maximum Travel Speed	5.4 km/h	3.4 mph
Maximum Drawbar Pull	113 kN	25,400 lbf

Swing Mechanism

Swing Speed	11.5 rpm
Swing Torque	30.9 kN·m 22,790 lbf-ft

Service Refill Capacities

Fuel Tank Capacity	178 L	47.0 gal
Cooling System	28 L	7.40 gal
Engine Oil (with filter)	13.5 L	3.6 gal
Swing Drive (each)	2.4 L	0.6 gal
Final Drive (each)	3 L	0.8 gal
Hydraulic System (including tank)	160 L	42.3 gal
Hydraulic Tank	84 L	22.2 gal

Track

Long Undercarriage	
Number of Shoes (each side)	46 pieces
Number of Track Rollers (each side)	7 pieces
Number of Carrier Rollers (each side)	2 pieces

Sound Performance

ISO 6396	
Operator Noise (Closed)	69 dB(A)
ISO 6395	
Spectator Noise	100 dB(A)

Dimensions

All dimensions are approximate.

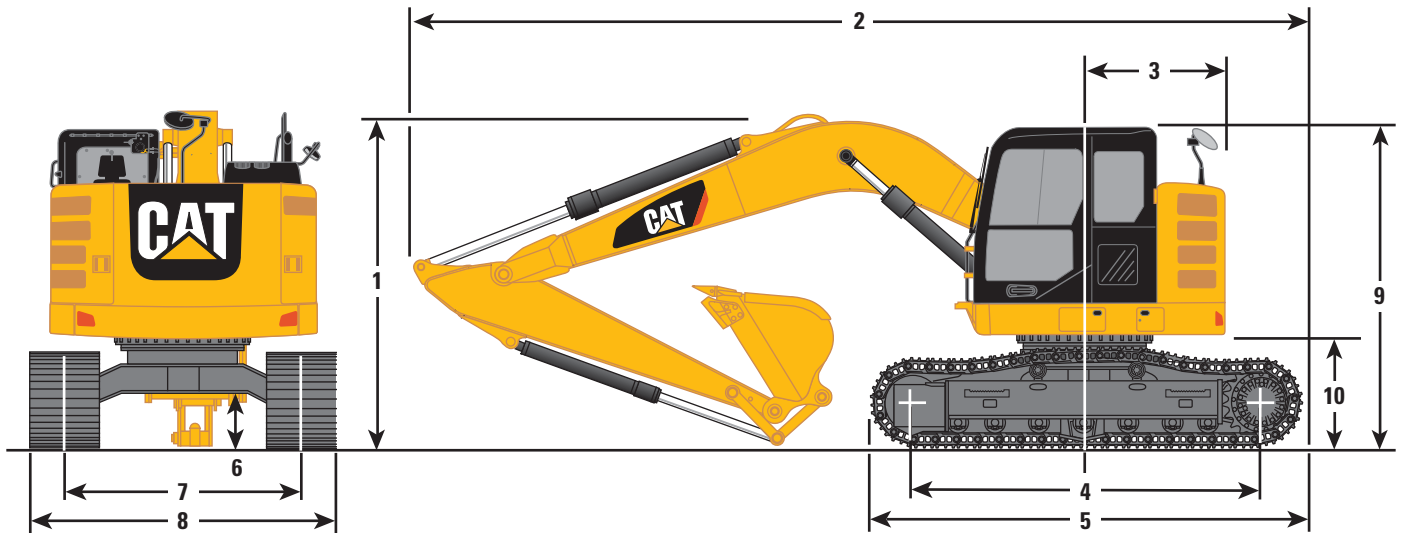

Stick	Reach Boom 4.65 m (15'3")				Power Offset Boom			
	R3.0 m (9'10")		R2.8 m (9'2")		R2.5 m (8'2")		2.13 m (6'11")	
1 Shipping Height*	3000 mm	9'10"	3030 mm	9'11"	3000 mm	9'10"	3000 mm	9'10"
Shipping Height at Boom Top	2750 mm	9'0"	3030 mm	9'11"	2820 mm	9'3"	2780 mm	9'1"
Shipping Height with Guard Rail	3000 mm	9'10"	3000 mm	9'10"	3000 mm	9'10"	3000 mm	9'10"
Shipping Height with Top Guard	2950 mm	9'8"	2950 mm	9'8"	2950 mm	9'8"	2950 mm	9'8"
2 Shipping Length								
Long Undercarriage	7450 mm	24'5"	7440 mm	24'5"	7450 mm	24'5"	7560 mm	24'10"
Long Undercarriage with Blade	8010 mm	26'3"	8010 mm	26'3"	8010 mm	26'3"	8120 mm	26'8"
3 Tail Swing Radius								
Standard Counterweight	1490 mm	4'11"	1490 mm	4'11"	1490 mm	4'11"	1490 mm	4'11"
Heavy Counterweight	1530 mm	5'0"	1530 mm	5'0"	1530 mm	5'0"	1530 mm	5'0"
4 Length to Center of Rollers	3040 mm	10'0"	3040 mm	10'0"	3040 mm	10'0"	3040 mm	10'0"
5 Track Length	3750 mm	12'4"	3750 mm	12'4"	3750 mm	12'4"	3750 mm	12'4"
6 Ground Clearance	440 mm	1'5"	440 mm	1'5"	440 mm	1'5"	440 mm	1'5"
7 Track Gauge	1990 mm	6'6"	1990 mm	6'6"	1990 mm	6'6"	1990 mm	6'6"
8 Transport Width								
500 mm (20") Shoes	2490 mm	8'2"	2490 mm	8'2"	2490 mm	8'2"	2490 mm	8'2"
600 mm (24") Shoes	2590 mm	8'6"	2590 mm	8'6"	2590 mm	8'6"	2590 mm	8'6"
700 mm (28") Shoes	2690 mm	8'10"	2690 mm	8'10"	2690 mm	8'10"	2690 mm	8'10"
9 Cab Height	2810 mm	9'3"	2810 mm	9'3"	2810 mm	9'3"	2810 mm	9'3"
Cab Height with Top Guard	2950 mm	9'8"	2950 mm	9'8"	2950 mm	9'8"	2950 mm	9'8"
10 Counterweight Clearance**	860 mm	2'10"	860 mm	2'10"	860 mm	2'10"	860 mm	2'10"

*Including shoe lug height.

**Without shoe lug height.

All dimensions were calculated with 900 mm (35") wide GD bucket with 0.53 m³ (0.69 yd³) capacity and 1200 mm (3'11") tip radius.

314E CR Hydraulic Excavator Specifications

Working Ranges

All dimensions are approximate.

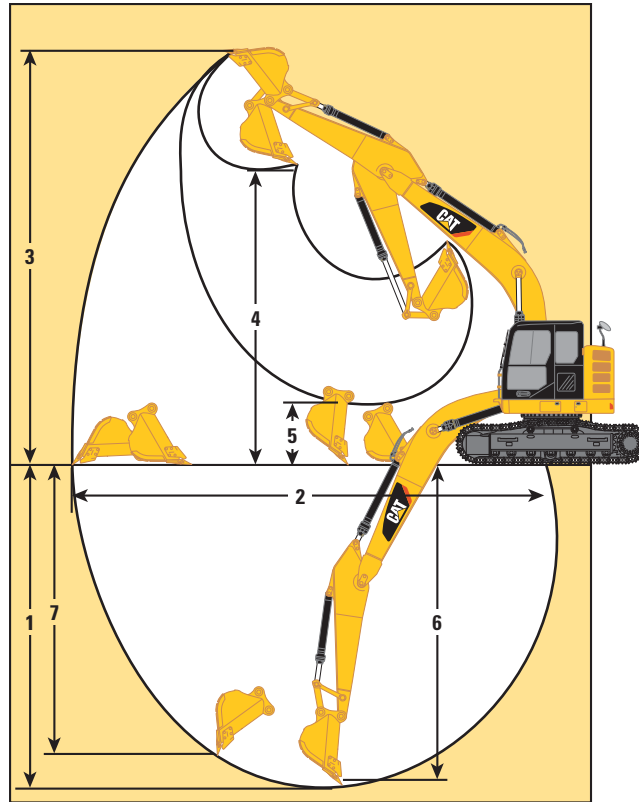

Stick	Reach Boom 4.65 m (15'3")					
	R3.0 m (9'10")		R2.8 m (9'2")		R2.5 m (8'2")	
1 Maximum Digging Depth	5950 mm	19'6"	5750 mm	18'10"	5450 mm	17'11"
2 Maximum Reach at Ground Level	8680 mm	28'6"	8490 mm	27'10"	8230 mm	27'0"
3 Maximum Cutting Height	9640 mm	31'8"	9480 mm	31'1"	9310 mm	30'7"
4 Maximum Loading Height	7190 mm	23'7"	7030 mm	23'1"	6860 mm	22'6"
5 Minimum Loading Height	2060 mm	6'9"	2240 mm	7'4"	2500 mm	8'2"
6 Maximum Depth Cut for 2440 mm (8'0") Level Bottom	5660 mm	18'7"	5460 mm	17'11"	5160 mm	16'11"
7 Maximum Vertical Wall Digging Depth	5280 mm	17'4"	5090 mm	16'8"	4880 mm	16'0"

All dimensions were calculated with 900 mm (35") wide GD bucket with 0.53 m³ (0.69 yd³) capacity and 1200 mm (3'11") tip radius.

Working Ranges

All dimensions are approximate.

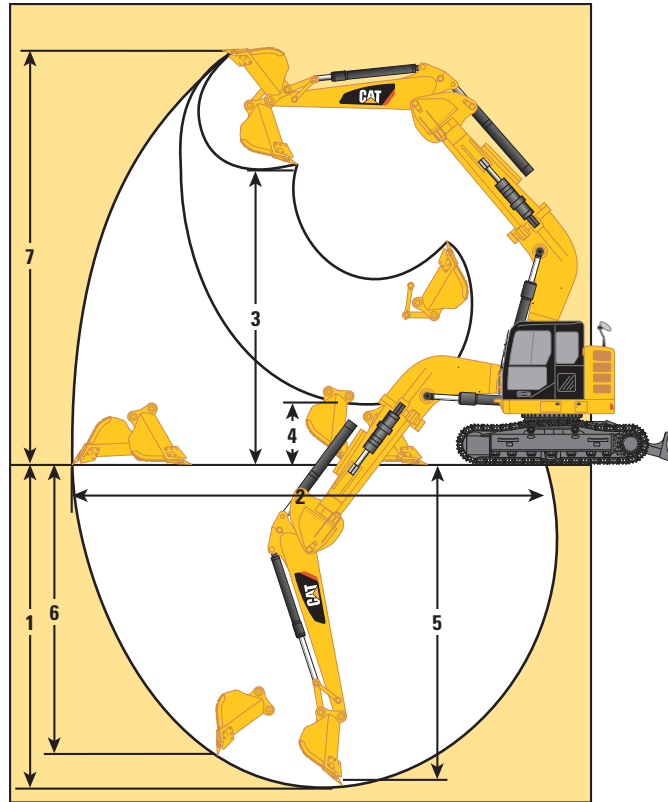

Stick	Power Offset Boom					
	2.13 m (6'11")*		2.13 m (6'11")		2.13 m (6'11")**	
1 Maximum Digging Depth	4510 mm	14'10"	4840 mm	15'11"	4480 mm	14'8"
2 Maximum Reach at Ground Level	6890 mm	22'7"	7270 mm	23'10"	6850 mm	22'6"
3 Maximum Cutting Height	8110 mm	26'7"	8450 mm	27'9"	8070 mm	26'7"
4 Maximum Loading Height	5680 mm	18'8"	6020 mm	19'9"	5640 mm	18'6"
5 Minimum Loading Height	2330 mm	7'8"	2680 mm	8'10"	2290 mm	7'6"
6 Maximum Depth Cut for 2440 mm (8'0") Level Bottom	4110 mm	13'6"	4450 mm	14'7"	4080 mm	13'5"
7 Maximum Vertical Wall Digging Depth	3270 mm	10'9"	3550 mm	11'8"	3240 mm	10'8"

*Left side 1100 mm (3'7") offset position

**Right side 1150 mm (3'9") offset position

All dimensions were calculated with 900 mm (35") wide GD bucket with 0.53 m³ (0.69 yd³) capacity and 1200 mm (3'11") tip radius.

314E CR Hydraulic Excavator Specifications

Blade Working Ranges

All dimensions are approximate.

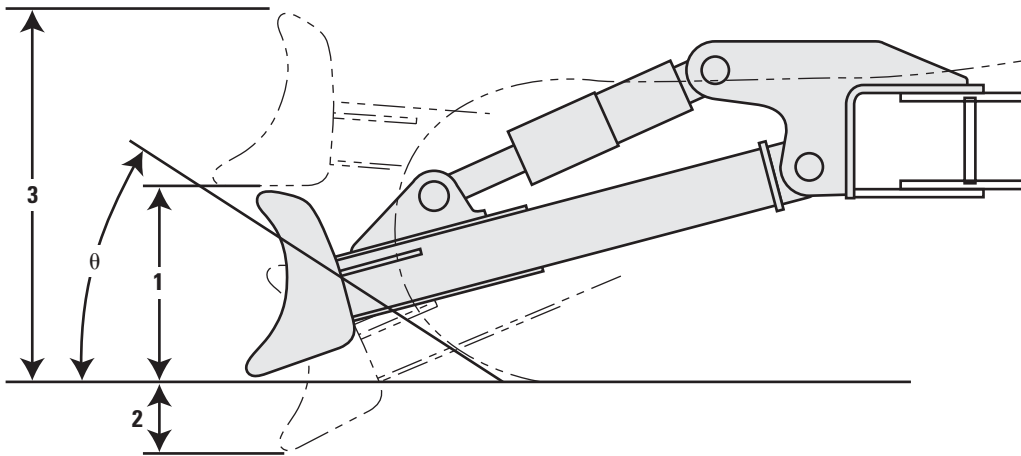

Blade Options	2500 mm (8'2")		2600 mm (8'6")		2700 mm (8'10")	
Recommended Track Shoe Width	500 mm (20")		600 mm (24")		700 mm (28")	
1 Blade Height	630 mm	2'1"	630 mm	2'1"	630 mm	2'1"
2 Maximum Lowering Depth from Ground	570 mm	1'10"	570 mm	1'10"	570 mm	1'10"
3 Maximum Raising Height above Ground	1000 mm	3'3"	1000 mm	3'3"	1000 mm	3'3"
θ Approach Angle	24.9 degrees		24.9 degrees		24.9 degrees	

Major Component Weights

Base Machine (with boom cylinder, without counterweight, front linkage and track)	5040 kg	11,110 lb
Long Undercarriage	2660 kg	5,870 lb
Counterweight		
Standard – 3.06 mt (3.4 t)	3060 kg	6,750 lb
Heavy – 3.56 mt (3.9 t)	3560 kg	7,850 lb
Boom (includes lines, pins and stick cylinder)		
Reach Boom – 4.65 m (15'3")	1040 kg	2,290 lb
Power Offset Boom	1730 kg	3,810 lb
Reach Boom for CGC – 4.65 m (15'3")	1050 kg	2,320 lb
Stick (includes lines, pins, bucket cylinder and bucket linkage)		
R3.0 m (9'10")	650 kg	1,430 lb
R2.8 m (9'2")	620 kg	1,370 lb
R2.5 m (8'2")	570 kg	1,260 lb
2.13 m (6'11") for Power Offset Boom	570 kg	1,260 lb
R3.0 m (9'10") for CGC	650 kg	1,430 lb
R3.0 m (9'10") for Thumb	700 kg	1,540 lb
Track Shoe (Long/per two tracks)		
500 mm (20") Triple Grouser	1570 kg	3,460 lb
500 mm (20") Triple Grouser with Rubber Pad	2080 kg	4,590 lb
600 mm (24") Triple Grouser	1820 kg	4,010 lb
700 mm (28") Triple Grouser	2090 kg	4,610 lb
Blade		
2500 mm (8'2")	810 kg	1,790 lb
2600 mm (8'6")	810 kg	1,790 lb
2700 mm (8'10")	820 kg	1,810 lb

All weights are rounded up to nearest 10 kg and lb. Kg and lb were rounded up separately so some of the kg and lb do not match.

Base machine includes 75 kg (170 lb) operator weight, 90% fuel weight, and undercarriage with center guard.

314E CR Hydraulic Excavator Specifications

Operating Weight and Ground Pressure

	700 mm (28") Triple Grouser Shoes				600 mm (24") Triple Grouser Shoes				500 mm (20") Triple Grouser Shoes			
	kg	lb	kPa	psi	kg	lb	kPa	psi	kg	lb	kPa	psi
Long Undercarriage without Blade, with Standard Counterweight												
Reach Boom – 4.65 m (15'3")												
R3.0 m (9'10")	15 100	33,300	32.1	4.66	14 800	32,600	36.7	5.32	14 600	32,200	43.5	6.31
R2.8 m (9'2")	15 000	33,100	31.9	4.63	14 800	32,600	36.7	5.32	14 500	32,000	43.2	6.27
R2.5 m (8'2")	15 000	33,100	31.9	4.63	14 700	32,400	36.5	5.32	14 500	32,000	43.2	6.27
Long Undercarriage with Blade, with Standard Counterweight												
Reach Boom – 4.65 m (15'3")												
R3.0 m (9'10")	15 900	35,000	33.8	4.90	15 600	34,400	38.7	5.61	15 400	34,000	45.9	6.66
R2.8 m (9'2")	15 900	35,000	33.8	4.90	15 600	34,400	38.7	5.61	15 300	33,700	45.6	6.61
R2.5 m (8'2")	15 800	34,800	33.6	4.87	15 600	34,400	38.7	5.61	15 300	33,700	45.6	6.61
Power Offset Boom												
2.13 m (6'11")	16 500	36,400	35.1	5.09	16 200	35,700	40.2	5.83	15 900	35,000	47.4	6.87
Long Undercarriage without Blade, with Heavy Counterweight												
Reach Boom – 4.65 m (15'3")												
R3.0 m (9'10")	15 600	34,400	33.2	4.82	15 300	33,700	38.0	5.51	15 100	33,300	45.0	6.53
R2.8 m (9'2")	15 500	34,200	33.0	4.79	15 300	33,700	38.0	5.51	15 000	33,100	44.7	6.48
R2.5 m (8'2")	15 500	34,200	33.0	4.79	15 200	33,500	37.7	5.47	15 000	33,100	44.7	6.48
Long Undercarriage with Blade, with Heavy Counterweight												
Reach Boom – 4.65 m (15'3")												
R3.0 m (9'10")	16 400	36,200	34.9	5.06	16 100	35,500	40.0	5.80	15 900	35,100	47.4	6.87
R2.8 m (9'2")	16 400	36,200	34.9	5.06	16 100	35,500	40.0	5.80	15 800	34,800	47.1	6.83
R2.5 m (8'2")	16 300	35,900	34.7	5.03	16 100	35,500	40.0	5.80	15 800	34,800	47.1	6.83
Power Offset Boom												
2.13 m (6'11")	17 000	37,500	36.2	5.25	16 700	36,800	41.4	6.00	16 400	36,200	48.8	7.08

Bucket and Stick Forces

Stick	Reach Boom 4.65 m (15'3")				Power Offset Boom			
	R3.0 m (9'10")		R2.8 m (9'2")		R2.5 m (8'2")		2.13 m (6'11")	
General Duty								
Bucket Digging Force (SAE)	85 kN	19,200 lbf	85 kN	19,200 lbf	85 kN	19,200 lbf	78 kN	17,500 lbf
Stick Digging Force (SAE)	57 kN	12,800 lbf	60 kN	13,500 lbf	64 kN	14,300 lbf	61 kN	13,700 lbf
Severe Duty								
Bucket Digging Force (SAE)	84 kN	18,800 lbf	83 kN	18,700 lbf	83 kN	18,700 lbf	77 kN	17,200 lbf
Stick Digging Force (SAE)	57 kN	12,800 lbf	60 kN	13,400 lbf	63 kN	14,200 lbf	61 kN	13,700 lbf

Caterpillar recommends using appropriate work tools to maximize the value customers receive from our products. Use of work tools, including buckets, which are outside of Caterpillar's recommendations or specifications for weight, dimensions, flows, pressures, etc. may result in less-than-optimal performance, including but not limited to reductions in production, stability, reliability, and component durability. Improper use of a work tool resulting in sweeping, prying, twisting and/or catching of heavy loads will reduce the life of the boom and stick.

314E CR Hydraulic Excavator Specifications

Reach Boom Lift Capacities – Standard Counterweight: 3.06 mt (3.4 t) – Blade Down

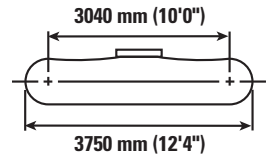
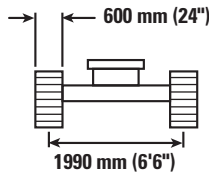
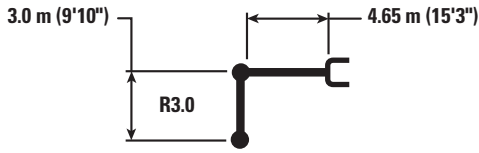

		1.5 m/5.0 ft		3.0 m/10.0 ft		4.5 m/15.0 ft		6.0 m/20.0 ft		7.5 m/25.0 ft		m ft		
7.5 m 25.0 ft	kg lb					*2600 *2600						*2500 *5,600	*2500 *5,600	4.54 14.33
6.0 m 20.0 ft	kg lb					*3450 *7,550		*2350 *2350				*2100 *4,650	*2100 *4,650	6.07 19.68
4.5 m 15.0 ft	kg lb					*3700 *8,050	*3700 *8,050	*3400 *7,400	2850 6,100			*2000 *4,350	*2000 *4,350	6.96 22.72
3.0 m 10.0 ft	kg lb			*5900 *12,700	*5900 *12,700	*4350 *9,450	4300 9,200	*3650 *7,900	2750 5,900			*2000 *4,350	1950 4,300	7.43 24.36
1.5 m 5.0 ft	kg lb			*8050 *17,350	7400 15,900	*5150 *11,150	4000 8,600	*3950 *8,550	2650 5,650			*2100 *4,550	1850 4,100	7.58 24.88
0.0 m 0.0 ft	kg lb			*7350 *16,950	6950 14,850	*5600 *12,100	3800 8,150	*4100 *8,850	2550 5,450			*2300 *5,050	1900 4,150	7.43 24.36
-1.5 m -5.0 ft	kg lb	*4550 *10,150	*4550 *10,150	*8050 *17,450	6800 14,600	*5400 *11,700	3700 7,900	*3900 *8,400	2500 5,350			*2700 *6,000	2050 4,500	6.94 22.73
-3.0 m -10.0 ft	kg lb	*7550 *16,950	*7550 *16,950	*6450 *13,950	*6450 *13,950	*4500 *9,650	3700 7,950	*2950 7,950	2500			*2850 *6,300	2500 5,500	6.04 19.71
-4.5 m -15.0 ft	kg lb			*3550 *7,350	*3550 *7,350							*2150 *4,500	*2150 *4,500	4.49 14.39

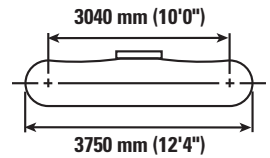
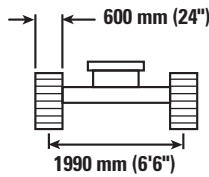
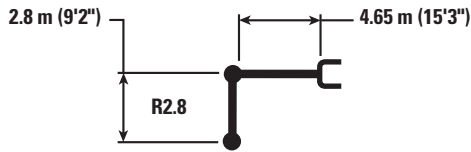

		1.5 m/5.0 ft		3.0 m/10.0 ft		4.5 m/15.0 ft		6.0 m/20.0 ft		7.5 m/25.0 ft		m ft		
7.5 m 25.0 ft	kg lb											*2750 *6,250	*2750 *6,250	4.21 13.20
6.0 m 20.0 ft	kg lb					*3650 *7,950	*3650 *7,950					*2300 *5,100	*2300 *5,100	5.83 18.88
4.5 m 15.0 ft	kg lb					*3850 *8,400	*3850 *8,400	*3500 *7,650	2850 6,100			*2150 *4,750	*2150 *4,750	6.75 22.03
3.0 m 10.0 ft	kg lb			*6300 *13,450	*6300 *13,450	*4550 *9,800	4250 9,150	*3750 *8,100	2750 5,900			*2150 *4,750	2050 4,500	7.24 23.72
1.5 m 5.0 ft	kg lb			*8300 *17,900	7350 15,750	*5300 *11,400	4000 8,600	*4000 *8,700	2650 5,700			*2250 *4,950	1950 4,250	7.39 24.26
0.0 m 0.0 ft	kg lb			*7050 *16,300	6950 14,900	*5650 *12,200	3800 8,150	*4150 *8,950	2550 5,500			*2500 *5,500	1950 4,300	7.23 23.73
-1.5 m -5.0 ft	kg lb	*4750 *10,600	*4750 *10,600	*7900 *17,100	6850 14,700	*5400 *11,650	3700 7,950	*3850 *8,300	2500 5,400			*3000 *6,600	2150 4,750	6.73 22.05
-3.0 m -10.0 ft	kg lb	*8100 *18,150	*8100 *18,150	*6200 *13,300	*6200 *13,300	*4350 *9,300	3750 8,000					*2900 *6,350	2650 5,900	5.80 18.91
-4.5 m -15.0 ft	kg lb											*2550 *2550	*2550 *2550	3.66



ISO 10567



Reach Boom Lift Capacities – Heavy Counterweight: 3.56 mt (3.9 t) – Blade Down

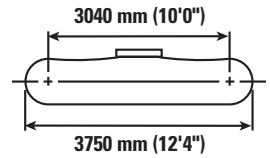
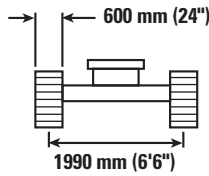
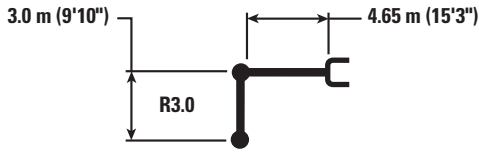

		1.5 m/5.0 ft		3.0 m/10.0 ft		4.5 m/15.0 ft		6.0 m/20.0 ft		7.5 m/25.0 ft		m ft	
7.5 m 25.0 ft	kg lb					*2600 *2600					*2500 *5,600	*2500 *5,600	4.54 14.33
6.0 m 20.0 ft	kg lb					*3450 *7,550	*3450 *7,550	*2350 *2350			*2100 *4,650	*2100 *4,650	6.07 19.68
4.5 m 15.0 ft	kg lb					*3700 *8,050	*3700 *8,050	*3400 *7,400	3050 6,500		*2000 *4,350	*2000 *4,350	6.96 22.72
3.0 m 10.0 ft	kg lb			*5900 *12,700	*5900 *12,700	*4350 *9,450	*4350 *9,450	*3650 *7,900	2950 6,350		*2000 *4,350	*2000 *4,350	7.43 24.36
1.5 m 5.0 ft	kg lb			*8050 *17,350	7900 16,950	*5150 *11,150	4300 9,200	*3950 *8,550	2850 6,100		*2100 *4,550	2000 4,400	7.58 24.88
0.0 m 0.0 ft	kg lb			*7350 *16,950	*7350 15,950	*5600 *12,100	4050 8,750	*4100 *8,850	2750 5,850		*2300 *5,050	2050 4,450	7.43 24.36
-1.5 m -5.0 ft	kg lb	*4550 *10,150	*4550 *10,150	*8050 *17,450	7300 15,700	*5400 *11,700	3950 8,500	*3900 *8,400	2650 5,750		*2700 *6,000	2200 4,850	6.94 22.73
-3.0 m -10.0 ft	kg lb	*7550 *16,950	*7550 *16,950	*6450 *13,950	*6450 *13,950	*4500 *9,650	3950 8,550	*2950 8,550	2700		*2850 *6,300	2700 5,950	6.04 19.71
-4.5 m -15.0 ft	kg lb			*3550 *7,350	*3550 *7,350						*2150 *4,500	*2150 *4,500	4.49 14.39

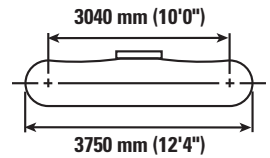
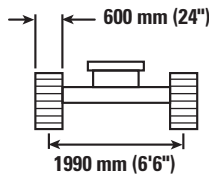
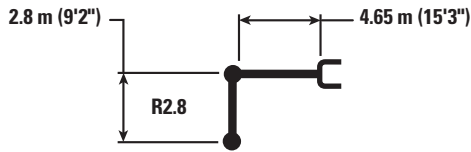

		1.5 m/5.0 ft		3.0 m/10.0 ft		4.5 m/15.0 ft		6.0 m/20.0 ft		7.5 m/25.0 ft		m ft	
7.5 m 25.0 ft	kg lb										*2750 *6,250	*2750 *6,250	4.21 13.20
6.0 m 20.0 ft	kg lb					*3650 *7,950	*3650 *7,950				*2300 *5,100	*2300 *5,100	5.83 18.88
4.5 m 15.0 ft	kg lb					*3850 *8,400	*3850 *8,400	*3500 *7,650	3050 6,500		*2150 *4,750	*2150 *4,750	6.75 22.03
3.0 m 10.0 ft	kg lb			*6300 *13,450	*6300 *13,450	*4550 *9,800	*4550 *9,750	*3750 *8,100	2950 6,350		*2150 *4,750	*2150 *4,750	7.24 23.72
1.5 m 5.0 ft	kg lb			*8300 *17,900	7850 16,850	*5300 *11,400	4250 9,200	*4000 *8,700	2850 6,100		*2250 *4,950	2100 4,600	7.39 24.26
0.0 m 0.0 ft	kg lb			*7050 *16,300	*7050 15,950	*5650 *12,200	4050 8,750	*4150 *8,950	2750 5,900		*2500 *5,500	2150 4,650	7.23 23.73
-1.5 m -5.0 ft	kg lb	*4750 *10,600	*4750 *10,600	*7900 *17,100	7350 15,800	*5400 *11,650	4000 8,550	*3850 *8,300	2700 5,800		*3000 *6,600	2350 5,100	6.73 22.05
-3.0 m -10.0 ft	kg lb	*8100 *18,150	*8100 *18,150	*6200 *13,300	*6200 *13,300	*4350 *9,300	4000 8,600				*2900 *6,350	2850 6,350	5.80 18.91
-4.5 m -15.0 ft	kg lb										*2550 *2550	*2550	3.66



ISO 10567



314E CR Hydraulic Excavator Specifications

Reach Boom Lift Capacities – Heavy Counterweight: 3.56 mt (3.9 t) – Blade Down

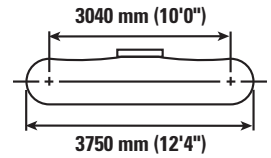
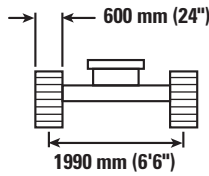
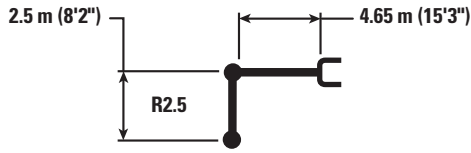

		1.5 m/5.0 ft		3.0 m/10.0 ft		4.5 m/15.0 ft		6.0 m/20.0 ft		7.5 m/25.0 ft		m ft		
7.5 m 25.0 ft	kg lb			*4450 *9,250	*4450 *9,250							*3050 *6,900	*3050 *6,900	3.74 11.57
6.0 m 20.0 ft	kg lb					*3900 *8,550	*3900 *8,550					*2400 *5,350	*2400 *5,350	5.51 17.79
4.5 m 15.0 ft	kg lb			*4550 *9,950	*4550 *9,950	*4100 *8,900	*4100 *8,900	*3700 *7,750	3000 6,450			*2250 *4,950	*2250 *4,950	6.47 21.11
3.0 m 10.0 ft	kg lb			*6800 *14,550	*6800 *14,550	*4750 *10,250	4500 9,700	*3850 *8,400	2950 6,300			*2250 *4,900	*2250 *4,900	6.98 22.87
1.5 m 5.0 ft	kg lb			*7250 *17,650	*7250 16,650	*5450 *11,750	4250 9,150	*4100 *8,900	2850 6,100			*2350 *5,150	2200 4,850	7.14 23.43
0.0 m 0.0 ft	kg lb			*6550 *15,100	*6550 *15,100	*5700 *12,300	4100 8,750	*4150 *8,950	2750 5,900			*2600 *5,700	2250 4,950	6.97 22.88
-1.5 m -5.0 ft	kg lb	*4950 *11,100	*4950 *11,100	*7600 *16,500	7400 15,900	*5300 *11,400	4000 8,650	*3750 *8,000	2750 5,850			*3150 *6,900	2500 5,450	6.45 21.13
-3.0 m -10.0 ft	kg lb	*7600 *16,350	*7600 *16,350	*5700 *12,250	*5700 *12,250	*4050 *8,600	*4050 *8,600					*2900 *6,300	*2900 *6,300	5.47 17.83

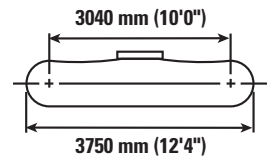
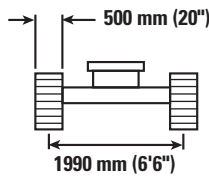
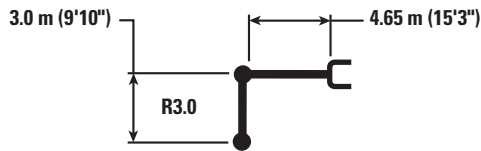

		1.5 m/5.0 ft		3.0 m/10.0 ft		4.5 m/15.0 ft		6.0 m/20.0 ft		7.5 m/25.0 ft		m ft		
7.5 m 25.0 ft	kg lb					*2600 *2600	*2600 *2600					*2500 *5,600	*2500 *5,600	4.54 14.33
6.0 m 20.0 ft	kg lb					*3450 *7,550	*3450 *7,550	*2350 *2350	*2350 *2350			*2100 *4,650	*2100 *4,650	6.07 19.68
4.5 m 15.0 ft	kg lb					*3700 *8,050	*3700 *8,050	*3400 *7,400	2950 6,300			*2000 *4,350	*2000 *4,350	6.96 22.72
3.0 m 10.0 ft	kg lb			*5900 *12,700	*5900 *12,700	*4350 *9,450	*4350 *9,450	*3650 *7,900	2850 6,100			*2000 *4,350	*2000 *4,350	7.43 24.36
1.5 m 5.0 ft	kg lb			*8050 *17,350	7550 16,250	*5150 *11,150	4100 8,850	*3950 *8,550	2750 5,850	*2500 1950		*2100 *4,550	1950 4,250	7.58 24.88
0.0 m 0.0 ft	kg lb			*7350 *16,950	7100 15,250	*5600 *12,100	3900 8,400	*4100 *8,850	2600 5,650			*2300 *5,050	1950 4,300	7.43 24.36
-1.5 m -5.0 ft	kg lb	*4550 *10,150	*4550 *10,150	*8050 *17,450	7000 15,000	*5400 *11,700	3800 8,150	*3900 *8,400	2550 5,500			*2700 *6,000	2100 4,650	6.94 22.73
-3.0 m -10.0 ft	kg lb	*7550 *16,950	*7550 *16,950	*6450 *13,950	*6450 *13,950	*4500 *9,650	3800 8,200	*2950 *2950	2600 2600			*2850 *6,300	2550 5,700	6.04 19.71
-4.5 m -15.0 ft	kg lb			*3550 *7,350	*3550 *7,350							*2150 *4,500	*2150 *4,500	4.49 14.39



ISO 10567



Reach Boom Lift Capacities – Heavy Counterweight: 3.56 mt (3.9 t) – Blade Down with Rubber Pad

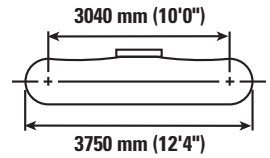
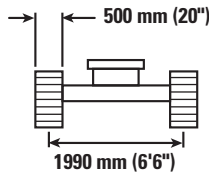
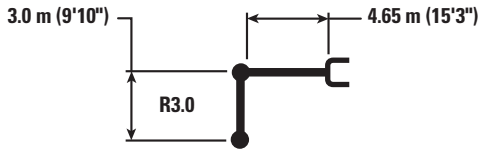

		1.5 m/5.0 ft		3.0 m/10.0 ft		4.5 m/15.0 ft		6.0 m/20.0 ft		7.5 m/25.0 ft		 m ft		
7.5 m 25.0 ft	kg lb					*2600 *2600					*2500 *5,600	*2500 *5,600	4.54 14.33	
6.0 m 20.0 ft	kg lb					*3450 *7,550	*3450 *7,550	*2350 *2350			*2100 *4,650	*2100 *4,650	6.07 19.68	
4.5 m 15.0 ft	kg lb					*3700 *8,050	*3700 *8,050	*3400 *7,400	3000 6,500			*2000 *4,350	*2000 *4,350	6.96 22.72
3.0 m 10.0 ft	kg lb			*5900 *12,700	*5900 *12,700	*4350 *9,450	*4350 *9,450	*3650 *7,900	2950 6,300			*2000 *4,350	*2000 *4,350	7.43 24.36
1.5 m 5.0 ft	kg lb			*8050 *17,350	7800 16,750	*5150 *11,150	4250 9,150	*3950 *8,550	2800 6,050	*2500 2050		*2100 *4,550	2000 4,400	7.58 24.88
0.0 m 0.0 ft	kg lb			*7350 *16,950	*7350 15,750	*5600 *12,100	4050 8,650	*4100 *8,850	2700 5,800			*2300 *5,050	2000 4,450	7.43 24.36
-1.5 m -5.0 ft	kg lb	*4550 *10,150	*4550 *10,150	*8050 *17,450	7250 15,500	*5400 *11,700	3950 8,450	*3900 *8,400	2650 5,700			*2700 *6,000	2200 4,850	6.94 22.73
-3.0 m -10.0 ft	kg lb	*7550 *16,950	*7550 *16,950	*6450 *13,950	*6450 *13,950	*4500 *9,650	3950 8,450	*2950 *8,450	2700			*2850 *6,300	2650 5,900	6.04 19.71
-4.5 m -15.0 ft	kg lb			*3550 *7,350	*3550 *7,350							*2150 *4,500	*2150 *4,500	4.49 14.39



ISO 10567



314E CR Hydraulic Excavator Specifications

Work Tool Offering Guide*

Boom Type	Reach Boom		
Stick Size	R3.0 m (9'10")	R2.8 m (9'2")	R2.5 m (8'2")
Hydraulic Hammer	H110Es H115Es	H110Es H115Es	H110Es H115Es
Mobile Scrap and Demolition Shear	S320B**	S320B**	S320B**
Compactor (Vibratory Plate)	CVP75	CVP75	CVP75
Contractors' Grapple	G112B	G112B	G112B
Trash Grapple			
Thumbs			
Rakes			
Center-Lock Pin Grabber Coupler			

These work tools are available for the 314E CR.
Consult your Cat dealer for proper match.

*Matches are dependent on excavator configurations. Consult your Cat dealer for proper work tool match.

**Boom Mount.

Bucket Specifications and Compatibility

	Width		Capacity		Weight		Fill	Reach Booms				POB**
	mm	in	m ³	yd ³	kg	lb		%	R3.0 m (9'10")	R2.8 m (9'2")	R2.5 m (8'2")	
Without Quick Coupler												
General Duty (GD)	450	18	0.20	0.27	276	608	100	●	●	●	●	●
	600	24	0.31	0.40	326	719	100	●	●	●	●	●
	750	30	0.41	0.54	374	823	100	●	●	●	●	●
	900	36	0.53	0.69	423	932	100	●	●	●	●	●
	1050	42	0.65	0.84	469	1,034	100	⊙	⊙	●	⊖	x
	1200	48	0.76	1.00	510	1,125	100	x	x	x	x	x
Severe Duty (SD)	600	24	0.31	0.40	367	810	90	●	●	●	●	●
	750	30	0.41	0.54	425	936	90	●	●	●	●	●
	900	36	0.53	0.69	483	1,065	90	●	●	●	●	●
	1050	42	0.65	0.84	529	1,166	90	⊙	●	●	⊖	x
Maximum load pin-on (payload + bucket)							kg	1605	1690	1815	1555	2275
							lb	3,537	3,725	4,000	3,427	5,014

	Width		Capacity		Weight		Fill	Reach Booms				POB**
	mm	in	m ³	yd ³	kg	lb		%	R3.0 m (9'10")	R2.8 m (9'2")	R2.5 m (8'2")	
With Center-Lock Quick Coupler												
General Duty (GD)	450	18	0.20	0.27	276	608	100	●	●	●	●	●
	600	24	0.31	0.40	326	719	100	●	●	●	●	●
	750	30	0.41	0.54	374	823	100	●	●	●	●	●
	900	36	0.53	0.69	423	932	100	⊙	⊙	●	⊖	●
	1050	42	0.65	0.84	469	1,034	100	○	⊖	⊖	○	●
	1200	48	0.76	1.00	510	1,125	100	◇	○	○	◇	⊙
Severe Duty (SD)	600	24	0.31	0.40	367	810	90	●	●	●	●	●
	750	30	0.41	0.54	425	936	90	●	●	●	●	●
	900	36	0.53	0.69	483	1,065	90	⊙	●	●	○	●
	1050	42	0.65	0.84	529	1,166	90	⊖	⊖	⊙	○	●
Maximum load with coupler (payload + bucket)							kg	1359	1444	1569	1309	2029
							lb	2,996	3,183	3,459	2,885	4,472

The above loads are in compliance with hydraulic excavator standard EN474, they do not exceed 87% of hydraulic lifting capacity or 75% of tipping capacity with front linkage fully extended at ground line with bucket curled.

Capacity based on ISO 7451.

Bucket weight with Long tips.

*Densities with 3.0 m (9'10") thumb stick do not consider thumb weight.

**POB installs blade as standard configuration.

Maximum Material Density:

- 2100 kg/m³ (3,500 lb/yd³)
- ⊙ 1800 kg/m³ (3,000 lb/yd³)
- ⊖ 1500 kg/m³ (2,500 lb/yd³)
- 1200 kg/m³ (2,000 lb/yd³)
- ◇ 900 kg/m³ (1,500 lb/yd³)
- x Not recommended

Caterpillar recommends using appropriate work tools to maximize the value customers receive from our products. Use of work tools, including buckets, which are outside of Caterpillar's recommendations or specifications for weight, dimensions, flows, pressures, etc. may result in less-than-optimal performance, including but not limited to reductions in production, stability, reliability, and component durability. Improper use of a work tool resulting in sweeping, prying, twisting and/or catching of heavy loads will reduce the life of the boom and stick.

Standard Equipment

Standard equipment may vary. Consult your Cat dealer for details.

CAB

- Pressurized operator station with positive filtration
- Sliding upper door window (left-hand cab door)
- Removable lower windshield with in cab storage bracket
- Coat hook
- Beverage holder
- Literature holder
- AM/FM radio
- Radio with MP3 auxiliary audio port
- Two stereo speakers
- Storage shelf suitable for lunch or toolbox
- Color LCD display with indicators, filter/fluid change, and working hour information
- Adjustable armrest
- Height adjustable joystick consoles
- Neutral lever (lock out) for all controls
- Travel control pedals with removable hand levers
- Capability of installing additional pedal
- Power outlets, 5 amp
- Travel alarm
- Laminated glass front upper window and tempered other windows

ELECTRICAL

- 80 amp alternator
- Circuit breaker
- Capability to electrically connect a beacon

ENGINE

- C4.4 diesel engine
- Biodiesel capable
- Meets EPA Tier 4 Interim emission standards
- 2300 m (7,500 ft) altitude capability
- Electric priming pump
- Automatic engine speed control
- Economy and high power modes
- Two-speed travel
- Side-by-side cooling system
- Radial seal air filter
- Primary filter with water separator and water separator indicator
- Secondary filter
- Screen filter in fuel line
- Variable speed fan with viscous clutch

HYDRAULIC SYSTEM

- Regeneration circuit for boom and stick
- Reverse swing dampening valve
- Automatic swing parking brake
- High-performance hydraulic return filter
- Fine swing control

LIGHTS

- Halogen boom light (left side)
- Time delay function for boom light and cab light
- Exterior light

UNDERCARRIAGE

- Center track guiding guard
- Grease Lubricated Track GLT2, resin seal
- Towing eye on base frame

SECURITY

- Cat one key security system
- Door locks
- Cap locks on fuel and hydraulic tanks
- Lockable external tool/storage box
- Signaling/warning horn
- Secondary engine shutoff switch
- Rear window for emergency exit
- Guard, travel motor protection
- Guard rail
- Rearview camera-ready

Optional Equipment

Optional equipment may vary. Consult your Cat dealer for details.

CAB

- Seat, high-back air suspension with heater and cooling
- Seat, high-back air suspension with heater
- Seat, high-back mechanical suspension
- Right pedal
- Rain protector
- Cab mirror
- Ashtray

COUNTERWEIGHT

- 3.06 mt (3.4 t) without lifting eye
- 3.56 mt (3.9 t) without lifting eye

ELECTRICAL

- Cold weather battery -25° C (-13° F)
- Jump start receptacle

ENGINE

- Quick drains, engine and hydraulic oil

FRONT LINKAGE

- Quick coupler
- Bucket linkage
- 4.65 m (15'3") Reach Boom
- Power Offset Boom
- 2.13 m (6'11") stick for Power Offset Boom
- 2.5 m (8'2") stick
- 2.8 m (9'2") stick
- 3.0 m (9'10") stick
- 3.0 m (9'10") thumb-ready stick

HYDRAULIC SYSTEM

- Control pattern quick-changer, two way
- Auxiliary hydraulics
- Boom and stick lines
- High-pressure line
- Medium-pressure line
- Quick coupler line
- Boom lowering and stick lowering control device
- Cat Bio hydraulic oil

LIGHTS

- Working light, cab mounted with time delay
- HID light, cab mounted with time delay
- Halogen boom lights (right side)

UNDERCARRIAGE

- 500 mm (20") triple grouser shoes
- 600 mm (24") triple grouser shoes
- 700 mm (28") triple grouser shoes
- Rubber pad for 500 mm (20") triple grouser shoes
- 2500 mm (8'2") blade with replaceable cutting edge
- 2600 mm (8'6") blade with replaceable cutting edge
- 2700 mm (8'10") blade with replaceable cutting edge
- Swivel guard

SECURITY

- FOGS, bolt-on
- Guard, cab front, mesh
- Guard, vandalism
- Security system fitted (MSS)
- Bottom guards, heavy duty
- Rearview camera

TECHNOLOGY

- Cat Grade Control Depth and Slope
- Product Link

