



Volvo Construction Equipment

EW145B PRIME

Volvo Excavators 12.8-15.0 t 150 hp



Experience the benefits

More safety

- **Safety** is a **core value** at Volvo and it shows in our machine.
- **Anti-slip steps and platforms** with punched steel plates for superior grip even when wet or icy.
- **Low engine emission levels and low noise.**
- **Lead-free exterior paint** is in harmony with the environment.
- **Recessed bolts on superstructure walk areas** for less risk of trip hazard.
- Volvo excavators are **95% recyclable.**

More profit

- **Powerful, innovative and efficient Volvo engine:** well-matched to hydraulic system, components and design.
- Volvo continues to deliver **industry-leading fuel efficiency.**
- **Proven hydraulics:** optimum power where it's needed.
- **Harmonized power** with oil regeneration and priority features for faster cycles and more productivity per shift.





More comfort

- **Large and comfortable cab** puts you in command with ergonomic controls.
- **Roomy and adjustable seat** supports your whole body.
- **Pivoting, ergonomic steering column** ensures clean lines of sight.

More uptime

- **Simplified, ground level serviceability** means more uptime.
- **Easy access, centralized lubrication points.**
- **Easy to learn, Easy to operate. Easy to get more done.**
- **Electronic control unit** monitors and troubleshoots all functions.
- **Easy-to-change cab air filter** is located inside the cab.
- **Cooling system is easier to clean.**

More quality

- **Strengthened undercarriage frame** endures daily abuse.
- **Reinforced boom/ arm and proven components** deliver every time.
- **Stabilizer dozer** has wide footprint, so it **won't damage pavement.**
- **Long wheel base** for added stability and smoother ride.

Volvo, a partner to trust

Trust means knowing your equipment will perform no matter the job or the conditions. Volvo EW145B prime wheeled excavators earn that trust — every day.

With the multi-task credentials of a tool carrier and the pedigree of a thoroughbred digging machine, the EW145B prime does more than work. It commands. Multi-function. Highly mobile. Well-balanced. Fuel efficient. Comfortable. Think of the Volvo EW145B prime as your one-machine fleet. It's time to roll.

Volvo: your global, local partner

Since 1927, Volvo has earned trust for providing solutions with true value. Built on core values of quality, safety and environmental care, Volvo equipment is a leader in construction and transportation. Its extensive lineup of construction machines is complemented by Volvo buses, trucks, aero engines and marine power systems. As the world's second largest producer of 9- to 18-liter diesel engines, Volvo delivers class-leading fuel efficiency. That heritage is born anew in the B-prime family of excavators. One shift in the cab of a Volvo excavator and you'll understand why so many count on Volvo as their trusted partner.

A task force from one machine

Other machines may try to claim the crown, but Volvo B prime-Series wheeled excavators are arguably the most capable construction machines at work anywhere. So what is an excavator doing making such claims? Watch and see. The EW145B prime is one machine, but it performs the work of a task force. Clearing ditches. Digging trenches. Moving construction debris. Stripping asphalt. Grading for building pads. Lifting and placing pipes.

Boring holes for utility poles. Cleaning storm debris from under bridges. All that in a well-balanced package that moves between job sites at up to 37 km/h. Low ground pressure makes the EW145B prime suited for work on pavement or in soft, off-road ground conditions. Its size and maneuverability help make it ideal for work in the city, at material handling sites, or inside buildings and warehouses. Count on it.

Cab puts the operator in command

The flow control option allows the operator to infinitely adjust hydraulic flow to attachments without leaving the seat as hydraulic oil flow can be monitored from the cab, thus resulting in improved operator convenience while reducing downtime which is apparent with manual setting. In addition, either high or low pressure can be selected via the monitor.





• Easy access for hydraulic pump filters.



• Efficient Volvo engine delivers high torque at very low RPMs.



• Simplified, ground level service access.



Volvo's engine leadership spans land, sea, sky and space

As the world's second largest manufacturer of 9-to-18-liter diesel engines, Volvo has unmatched expertise designing power systems that move the world. Volvo engines for Volvo Construction Equipment, Volvo

Aero, Volvo Buses, Volvo Penta and Volvo Trucks define productivity and fuel economy. Our performance has been honed on land, over the sea, across the sky and into space. Leading research and development keeps

all Volvo Group products at the forefront of productivity. So when we say Volvo engines are tested — and proven — you can believe it. Trust in it. It's the real advantage of Volvo Power.



Built to run, supported for life

Even the best machines need service and maintenance to be as productive tomorrow as they are today. With superior attention to detail, we've created a productivity chain of machines, parts and service. Our global Customer Support organization delivers the values you've come to expect from Volvo Construction Equipment.

We care about your operation - anywhere, anytime

Volvo Construction Equipment comes with a professional Customer Support organization providing genuine parts, aftersale service and training - providing you with controlled owning and operation costs. With all the products and resources at our disposal, we can offer you the best support there is. Anywhere, anytime.

Four levels of support, one level of care

The best way to get the most out of your Volvo is to invest in a Volvo Customer Support Agreement. Since business' needs vary, we've made it easy for you to select the agreement that's right for your business by creating four levels of Customer Support Agreements. We offer programs that provide everything from regular machine inspections to a comprehensive repair and maintenance program that takes the hassle and worry out of running a workshop and gives you total peace of mind.

CareTrack - fast and correct information

CareTrack is an optional GPS monitoring program that works with the machine's diagnostic system. Installation is simple. You and your dealer can remotely track usage, productivity, fuel consumption and more. Maximize uptime through important service reminders. CareTrack also monitors geographic machine location and can even prevent unauthorized use. With CareTrack, you can focus on the care of your business while your Volvo dealer focuses on the care of your machine.

MATRIS reports on your efficiency

MATRIS delivers detailed operating history analysis about the utilization and efficiency factors that influence your operating costs. MATRIS turns the data captured inside the machine's computer into easy-to-use graphs and reports. Maximize machine and operator performance, while reducing maintenance costs and increasing service life.

PROSIS makes parts ordering faster

PROSIS is a CD-ROM application that makes it quick and easy for your Volvo dealer to order all your Volvo CE product parts. Your dealer will help you find the right part, place your order and get you back up and running fast.



Standard and optional equipment may vary by market. Please consult your local Volvo dealer for details.



Specifications

Engine

The next-generation Volvo diesel engine uses Volvo Advanced Combustion Technology (V-ACT) to deliver lower emissions and maintain superior performance and fuel efficiency. The EU Stage IIIA compliant engine uses precise, high-pressure fuel injectors, turbo charger and air to air intercooler, and electronic engine controls to optimize machine performance.

Engine	Volvo D6E EIE3
Power output at	33.3 r/s (2 000 rpm)
Net (ISO 9249/SAE J1349)	102 kW (139 metric hp)
Gross (SAE J1995)	110 kW (150 metric hp)
Max. torque at 1,500 r/min	690 Nm
No. of cylinders	6
Displacement	5.7 l
Bore	98 mm
Stroke	126 mm

Electrical system

Contronics, provides advanced monitoring of machine functions and important diagnostic information. High capacity and well protected electrical system. Centrally located fuse and relay box using clearly arranged printed circuit board mounted, for easy access, behind the cab.

Voltage	24 V
Batteries	2 x 12 V
Battery capacity	120 Ah
Alternator	28 V / 80 A
Alternator rating	2 240 W

Cab

The operator's cab has easy access via a wide door opening. The cab is supported on hydraulic dampening mounts to reduce shock and vibration levels. These along with a sound absorbing lining provide low noise levels. The cab has excellent all-round visibility. The front windshield can easily slide up into the ceiling, and the lower front glass can be removed and stored in the door.

Integrated air conditioning and heating system: The pressurized and filtered cab air is supplied by an automatically controlled fan. The air is distributed throughout the cab from 13 vents.

Ergonomic operator's seat: The adjustable seat and joystick console move independently to accommodate the operator. The seat has nine different adjustments plus a seat belt for the operator's comfort and safety.

Sound level in cab according to ISO 6396:	LpA 72 dB(A)
External sound level according to ISO 6395 and EU Directive 2000/14/EC:	LwA 100 dB(A)

Undercarriage

Drive train: One big variable axial-piston motor on the two-step Power Shift gearbox gives power to front and rear axles, both with hub reductions.

Framework: All-welded robust torsion box frame.

Wheels: Twin wheels available.

Front axle: Robust excavator axle with automatic or operator controlled front axle oscillation lock. Oscillating $\pm 6.5^\circ$.

Twin wheels	9.00 x 20-14PR
Max. tractive force (net)	7.5 ton (74.7 kN)
Travel speed, on road	37 km/h
Travel speed, off road	10 km/h
Travel speed, creep	3.6 km/h
Min. turning radius	6.9 m
System pressure	330 / 350 kg.cm ²

Brakes

Service brakes: Servo-hydraulically manoeuvred self-adjusting wet multidiscs in two separate brake circuits.

Parking brake: Negative wet disc in gear housing, spring applied and pressure released.

Digging brake: Service brake with mechanical lock system.

Security system: The 2-circuit travel brakes are supplied with two accumulators in the event of failure in the service brake system.

Weights

Machine with 4.4 m boom, 2.1 m arm and 0.57 l bucket.

Total machine weight incl. rear dozer blade	13,100 kg
--	-----------

Service refill capacities

Fuel tank	260 l
Hydraulic system, total	265 l
Hydraulic tank	95 l
Engine oil	25 l
Engine coolant	28 l
Transmission	2.5 l
Axle housing	
Front axle	9 l
Rear axle	11.2 l
Hub reduction gear	4 x 2.4 l

Hydraulic system

The hydraulic system, named "Automatic Work Mode", is designed for high productivity, high digging capacity, high maneuvering precision and good fuel economy. The summation system, boom priority, arm priority, swing priority and regeneration system of boom and arm flow are provided for the best operation.

The following important functions are included in the system:

Summation system: Combines the flow of both hydraulic pumps to ensure quick cycle times and high productivity.

Boom priority: Gives priority to the boom operation for faster raising when loading or deep excavations.

Arm priority: Gives priority to the arm operation for faster cycle times in leveling and for increased bucket filling when digging.

Swing priority: Supplies priority to the swing operation for faster swing during simultaneous operations.

Regeneration system: Prevents cavitation and provides flow to other movements during simultaneous operations for maximum productivity.

Power boost: All digging, lifting and tractive forces are increased.

Holding valves: Boom and arm holding valves prevent the digging equipment from creeping.

The following working modes are included in the system:

Parking mode (P): Parking position for optimal safety.

Travel mode (T): Engine speed is controlled by travel pedal stroke and mode selection switch for low fuel consumption and noise. Work equipment are not able to move at this mode for optimal safety.

Working mode (W): Full working flow with adjustable engine rpm for normal working and best speed utilisation.

Creeping mode (C): Additional working mode for fixed lower travel speed 3.6 km/h.

Hydraulic pumps:

Main pump	
Type	2 x variable displacement axial piston pumps
Maximum flow	2 x 160 l/min

Pilot pump

Type	Gear pump
Maximum flow	1 x 20 l/min

Brake + steering pump

Type	Low noise gear pump
Maximum flow	36 + 16 l/min

Hydraulic motors

Travel	Variable displacement axial piston motor
Swing	Fixed displacement piston motor with mechanical brake

Relief valve setting

Implement	32.4 / 34.3 Mpa
Travel system	34.3 Mpa
Swing system	26.5 Mpa
Pilot system	3.9 Mpa

Hydraulic cylinders

Boom	2
Bore x Stroke	$\varnothing 110 \times 980$ mm
Arm	1
Bore x Stroke	$\varnothing 120 \times 1\ 030$ mm
Bucket	1
Bore x Stroke	$\varnothing 100 \times 865$ mm
Dozer blade	2
Bore x Stroke	$\varnothing 100 \times 293$ mm

Swing system

The superstructure is swung by the means of an axial piston motor with a planetary reduction gear. Automatic swing holding brake and anti-rebound valve are standard.

Max. swing speed	12.2 rpm
-------------------------	----------

BUCKET SPECIFICATIONS

• EW145B prime with direct fit bucket

Bucket type	Capacity	Width	Weight	Teeth	Recommended maximum material density (kg/m ³)
					4.4 m boom
Application	l	mm	kg	EA	G 2.1 m
GP	520	1 010	460	5	1 800
	570	1 090	480	5	1 800
HD	520	1 010	550	5	1 800
	570	1 090	570	5	1 800
Maximum load	-				1 800

• EW145B prime with quick fit bucket

Bucket type	Capacity	Width	Weight	Teeth	Recommended maximum material density (kg/m ³)
					4.4 m boom
Application	l	mm	kg	EA	G 2.1 m
GP	580	1 000	407	4	1 800
Maximum load	-				1 800

• EW145B prime dozer blade with direct fit bucket

Bucket type	Capacity	Width	Weight	Teeth	Recommended maximum material density (kg/m ³)
					4.4 m boom
Application	l	mm	kg	EA	G 2.1 m
GP	520	1 010	460	5	1 800
	570	1 090	480	5	1 800
HD	520	1 010	550	5	1 800
	570	1 090	570	5	1 800
Maximum load	-				1 833

• EW145B prime dozer blade with quick fit bucket

Bucket type	Capacity	Width	Weight	Teeth	Recommended maximum material density (kg/m ³)
					4.4 m boom
Application	l	mm	kg	EA	G 2.1 m
GP	580	1 000	407	4	1 800
Maximum load	-				1 833

Notes: Please consult with your Volvo dealer for the proper match of buckets and attachments to suit the application.
 The recommendations are given as a guide only, based on typical operation conditions.
 Bucket capacity based on ISO 7451, heaped material with a 1:1 angle of repose.
 Maximum load : Payload, bucket and additional tools such as quick fit, rotator.
 VA Boom : Variable angle boom or two-piece boom.

Specifications

DIMENSIONS

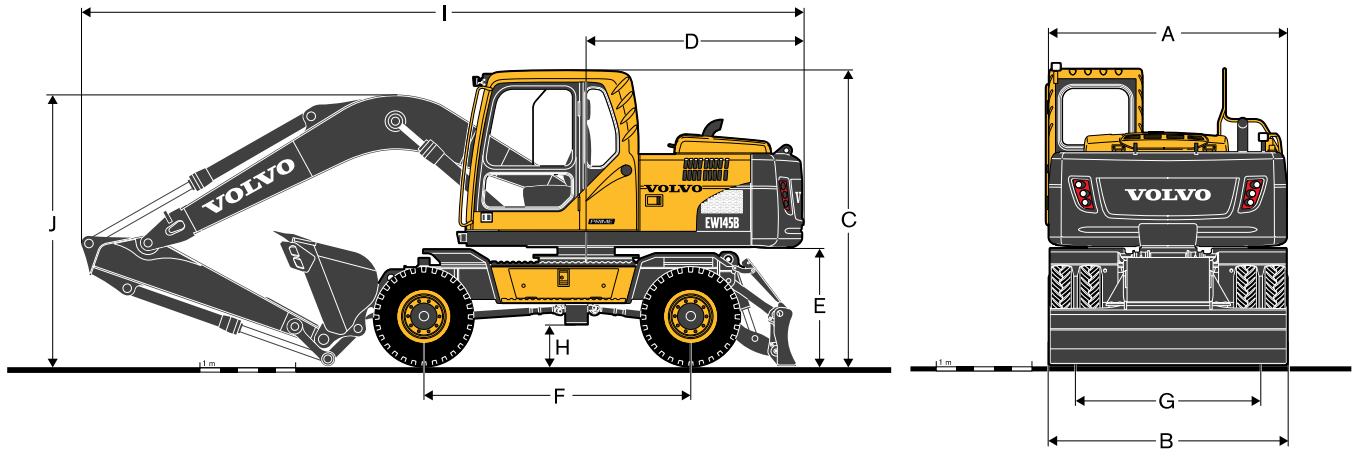

Description	Unit	4.4 m boom
		2.1 m arm
A. Overall width of superstructure	mm	2 490
B. Overall width	mm	2 500
C. Overall height of cab	mm	3 058
D. Tail swing radius	mm	2 290
E. Counterweight clearance	mm	1 208
F. Wheel base	mm	2 800
G. Tread	mm	1 944
H. Min. ground clearance	mm	350
I. Overall length	mm	7 479
J. Overall height of boom	mm	3 543

• Boom

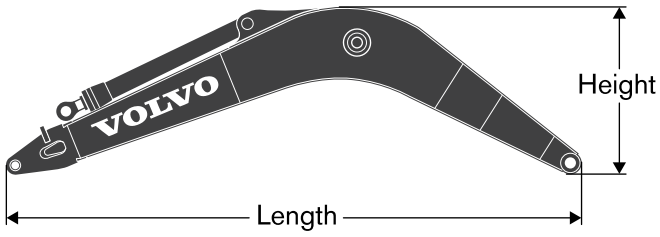

Description	Unit	4.4 m
Length	mm	4 565
Height	mm	1 330
Width	mm	544
Weight	kg	1 021

* Includes cylinder, piping and pin

• Arm

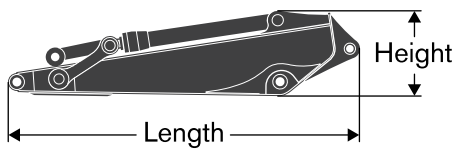

Description	Unit	2.1 m
Length	mm	2 805
Height	mm	690
Width	mm	250
Weight	kg	532

* Includes cylinder, piping and linkage

• Rear dozer blade



Description	Unit	Measurement
Height	mm	570
Width	mm	2 496
Weight	kg	474
Lift height	mm	505

Specifications

WORKING RANGES & DIGGING FORCES

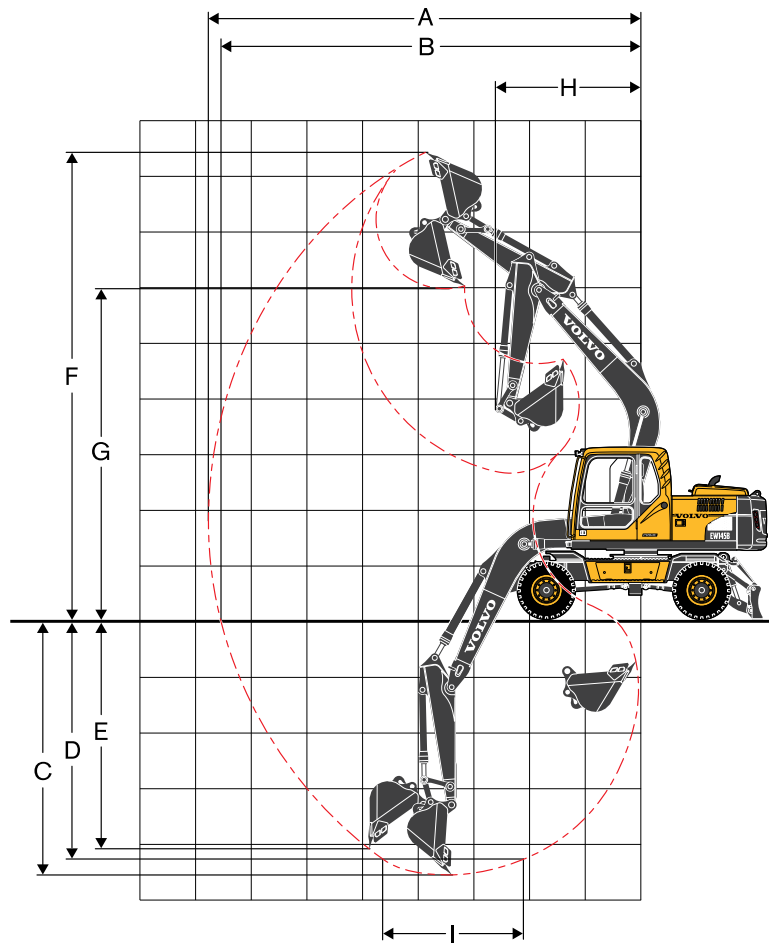















Machine with direct fit bucket	Unit	4.4 m boom
		2.1 m arm
A. Max. digging reach	mm	7 770
B. Max. digging reach on ground	mm	7 544
C. Max. digging depth	mm	4 700
D. Max. digging depth (2.44 m level)	mm	4 396
E. Max. vertical wall digging depth	mm	4 116
F. Max. cutting height	mm	8 395
G. Max. dumping height	mm	5 943
H. Min. front swing radius	mm	2 613

Digging forces with direct fit bucket		Unit	4.4 m boom
			2.1 m arm
Bucket radius		mm	1 250
Breakout force – bucket (Normal / Power boost)	SAE J1179	kN	81.4 / 86.3
	ISO 6015	kN	92.1 / 97.7
Tearout force – arm (Normal / Power boost)	SAE J1179	kN	69.0 / 73.3
	ISO 6015	kN	71.4 / 75.7
Rotation angle, bucket		deg	174

LIFTING CAPACITY

At the end, without bucket. Unit: 1,000 kg

For lifting capacity including bucket, simply subtract actual weight of bucket from the following values.

 Across undercarriage  Along undercarriage	Lifting hook related to ground level	2.0 m		3.0 m		4.0 m		5.0 m		6.0 m		Max. reach			
														Max. m	
Boom 4.4 m + Arm 2.1 m + Counterweight 1 650 kg + Dozer blade up	7.0 m	kg											*3 910	*3 910	3.74
	6.0 m	kg					*3 460	*3 460					*3 870	2 610	4.89
	5.0 m	kg					*3 460	3 460	*3 780	2 530			*3 640	2 050	5.63
	4.0 m	kg			*4 850	*4 850	*4 310	3 500	*4 060	2 460	3 770	1 820	*3 580	1 760	6.11
	3.0 m	kg			*7 020	5 070	*5 310	3 300	*4 580	2 360	3 730	1 780	3 350	1 600	6.40
	2.0 m	kg					*6 390	3 100	4 900	2 260	3 660	1 720	3 210	1 510	6.51
	1.0 m	kg					6 960	2 950	4 790	2 160	3 600	1 670	3 210	1 500	6.47
	0 m	kg			*8 220	4 340	6 850	2 860	4 720	2 100	3 560	1 640	3 350	1 550	6.26
	-1.0 m	kg	*6 450	*6 450	*10 650	4 350	6 820	2 830	4 690	2 080			3 680	1 690	5.87
	-2.0 m	kg	*10 510	9 040	*10 040	4 400	6 850	2 860	4 720	2 110			4 390	1 980	5.25
-3.0 m	kg			*8 720	4 530	*6 480	2 960					*5 810	2 680	4.31	
Boom 4.4 m + Arm 2.1 m + Counterweight 1 650 kg + Dozer blade down	7.0 m	kg											*3 910	*3 910	3.74
	6.0 m	kg					*3 460	*3 460					*3 870	3 020	4.89
	5.0 m	kg					*3 640	*3 640	*3 780	2 920			*3 640	2 370	5.63
	4.0 m	kg			*4 850	*4 850	*4 310	4 070	*4 060	2 850	*4 060	2 110	*3 580	2 040	6.11
	3.0 m	kg			*7 020	6 040	*5 310	3 860	*4 580	2 750	*4 250	2 070	*3 630	1 860	6.40
	2.0 m	kg					*6 390	3 650	*5 170	2 640	*4 560	2 010	*3 780	1 770	6.51
	1.0 m	kg					*7 260	3 490	*5 700	2 540	*4 860	1 960	*4 070	1 760	6.47
	0 m	kg			*8 220	5 260	*7 750	3 400	*6 070	2 480	4 920	1 930	*4 550	1 820	6.26
	-1.0 m	kg	*6 450	*6 450	*10 650	5 260	*7 860	3 370	*6 170	2 460			5 100	1 980	5.87
	-2.0 m	kg	*10 510	*10 510	*10 040	5 320	*7 550	3 400	*5 850	2 490			*5 450	2 330	5.25
-3.0 m	kg			*8 720	5 450	*6 480	3 500					*5 810	3 160	4.31	

Notes: 1. Working pressure with Power Boost = 34.3 MPa

2. The above values are in compliance with ISO standard 10567. They do not exceed 87% of hydraulic lifting capacity or 75% of tipping load, with the machine on firm, level ground.

3. Load capacities marked with an asterisk (*) are limited by machine's hydraulic lifting capacity rather than tipping load.

Equipment

STANDARD EQUIPMENT

Engine

Turbocharged, 4 stroke Volvo diesel engine with water cooling, common rail direct injection and charged air cooler that meets EU Step IIIA emission requirements
Air filter with indicator
Air intake heater
Electric engine shut-off
Fuel filter and water separator

Electric / Electronic control system

Contronics – computerized monitoring and diagnostic system
GSM/GPS Caretrack
Master electrical disconnect system
Automatic idling system
One-touch power boost
Adjustable monitor
Engine restart prevention circuit
Travel alarm
High capacity halogen lamps:

- Frame mounted 2
- Cab mounted 2

Batteries, 2 x 12 V/120 Ah
Start motor, 24 V/5.5 kW

Hydraulic system

Automatic hydraulic system:

- Summation system
- Boom priority
- Arm priority
- Swing priority

Boom and arm regeneration valves
Swing anti-rebound valves
Boom and arm holding valves
Multi-stage filtering system
Cylinder cushioning
Cylinder contamination seals

Superstructure

Service walkway with anti-slip grating
Centralized lubricating point for swing bearing
Counterweight: 1 650 kg

Cab and interior

Hydraulic dampening cab mounts
Adjustable operator seat and joystick control console
Adjustable steering wheel
Flexible antenna
Hydraulic control lockout lever
Control joystick
Cab, all-weather sound suppressed, includes:

- Cup holder

- Tinted glass
- Door locks
- Floor mat
- Horn
- Large storage area
- Pull-up type front window
- Removable lower windshield
- Seat belt
- Safety glass
- Windshield wiper with intermittent feature
- Radio preparation

Undercarriage

2-speed power transmission plus creep
Oscillating front axle $\pm 6,5^\circ$
2-circuit travel brakes
Maintenance-free propeller shafts
Rear dozer blade with cylinder protection cover
Tire: 900-20-14 PR

Digging equipment

Boom: 4.4 m monoblock
Arm: 2.1 m
Attachment points for extra hydraulics
Manual centralized lubrication

OPTIONAL EQUIPMENT

Engine

Water separator with heater

Electric / Electronic control system

Rotating warning beacon
Extra work lights:

- Cab-mounted 3, (front 2, rear 1)
- Counterweight-mounted 1

Fuel filler pump: 35 l/min
Cleaning air gun
Micro phone

Hydraulic system

Hydraulic piping:

- Breaker & shear piping: pump flow control for break & shear
- Quick coupler piping

Hydraulic oil, ISO VG 32, 46, 68

Cab and interior

Fabric seat with heater
Fabric seat with heater and air suspension
Heater & air conditioner, automatic
Falling object protective structure (FOPS)
Rain shield, front
Sunlight protection, roof (steel)
Safety screen for front window
X1 electric pedal
AM/FM stereo
AM/FM stereo MP3/AUX

Service

Tool kit
Spare parts kit
Oil, coolant, grease

Standard and optional equipment may vary by market. Please consult your local Volvo dealer for details.

Not all products are available in all markets. Under our policy of continuous improvement, we reserve the right to change specifications and design without prior notice. The illustrations do not necessarily show the standard version of the machine.

NOTE

VOLVO

Volvo Construction Equipment

www.volvoce.com