

**KOBELCO**

HYDRAULIC EXCAVATORS

**SK200**  
MARK-VI SUPER  
**SK200LC**  
MARK-VI SUPER

Bucket Capacity: 0.51 - 1.30 m<sup>3</sup> SAE heaped  
Engine Power: 110 kW (150 PS) SAE NET at 2,000 rpm  
Operating Weight: 20,700 kg with 800 mm shoe —  
SK200 MARK-VI SUPER  
21,100 kg with 800 mm shoe —  
SK200LC MARK-VI SUPER

***Dynamic  
Acera***





**KOBELCO**



*Dynamic  
Acera*

# Rediscover the Ultimate in Dynamic Performance: **THE DYNAMIC ACERA SK200/SK200LC MARK-VI SUPER!**

The machines in the Dynamic Acera Series have earned a worldwide reputation for their power and reliability. Now we've taken that excellent combination one step further with the SK200/SK200LC MARK-VI SUPER. Stronger, more durable, and more powerful than ever, this tough all-around machine can handle civil engineering, rock removal, demolition, and many other tasks quickly and efficiently. Its new reinforced design keeps you on the job day after day, year after year, while enjoying the comfort, precise control, and maneuverability you've come to expect from KOBELCO. The SK200/SK200LC MARK-VI SUPER: rediscover what ultimate performance is all about!



# Extra Power and Stronger Structure Mean Superior Performance.

## POWER UP!

### High-Output yet Environment Friendly Engine

The high-output engine with intercooler features an ESS (Engine Speed Sensing) system and total horsepower control system that ensure the most efficient use of horsepower at all times. Engine complies with Tier II (European) Regulations.

*Rated Output: 110 kW (150 PS)*

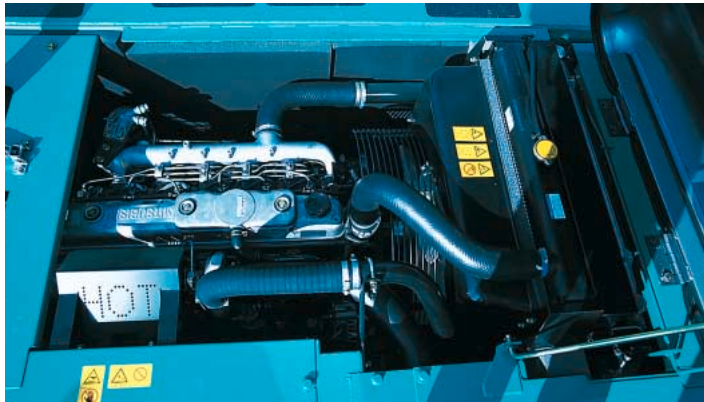

### Stronger Digging Forces for the Toughest Jobs

With max. discharge pressure set at a high 34.3 MPa, the SK200/SK200LC MARK-VI SUPER has power to spare for boom hoisting and other operations. Bucket digging force has been increased by 6% to handle the toughest jobs. And even when that's not enough, the one-push Power Boost feature provides an added 10%, without any time limit or cut in hydraulic flow.

- Bucket Digging Force: 143 kN*
- With Power-Boost activated: 157 kN*
- Arm Crowding Force: 97.1 kN*
- With Power-Boost activated: 107 kN*

### Powerful Drawbar Pull

High-performance travel system ensures powerful drawbar pulling force.

*Drawbar pull: 199 kN*

## RUGGED STRUCTURE!

### Reinforced Body Can Handle a Wide Variety of Jobs

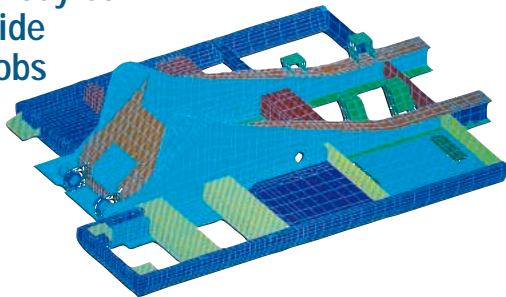

With steel plate used in the upper body and boom support section, the SK200/SK200LC MARK-VI SUPER is tougher and more durable than ever, providing strong and stable support for long and heavy attachments. High-tensile steel plate is also used in the crawler frame and carbody.

### New X-Chassis with Innovative Crawler Frame

The joint between the chassis and crawler frame has been further reinforced to make the chassis even more resistant to torsion. The new design of the crawler frame makes mud removal easy.

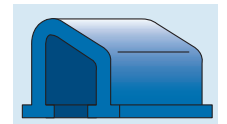

**New design of crawler frame**

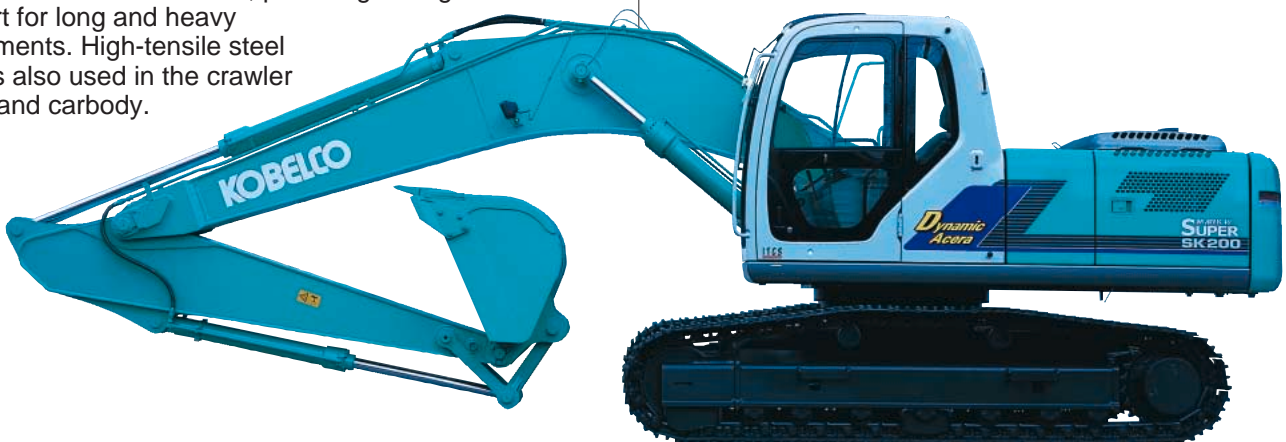

# C O N T R O L

## Revolutionary KOBELCO Control System

### ULTIMATE CONTROLLABILITY!

#### Electronic Positive Control Ensures Excellent Responsiveness

With the improved ITCS system and the introduction of electronic positive control, control lever action is conveyed directly to the hydraulic pump. The operator gets exactly the response he wants: smooth, precise control; excellent stability; and steady speed during simultaneous operations.



#### Three Working Modes



##### Manual Mode (default setting)

This mode features crisp control and maximum engine output to boost operating capacity for hard digging and loading.



##### Assist Mode

The computerized ITCS (Intelligent Total Control System) system uses fuzzy logic to automatically analyze operational patterns and optimize machine output to achieve maximum efficiency.



##### Breaker Mode

The operator can control pump flow from his seat to match the breaker being used. During breaker operation, the system automatically adjusts the flow to preset value; at other operations, normal hydraulic flow is maintained.



#### Assist Mode Display Sample

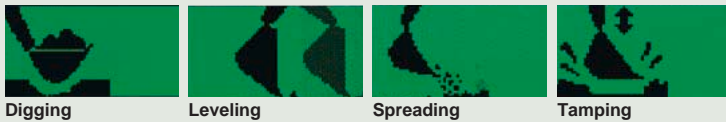

#### Electronic Active Control System

This advanced system provides sensitive and accurate response in proportion to the lever stroke while ensuring shockless starts and stops.

#### Smooth Automatic Deceleration

When the control levers are in neutral, the engine automatically reduces speed to effectively save fuel.

Engine speed increases smoothly in response to lever stroke.

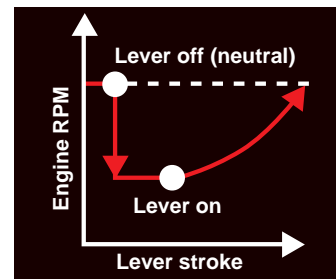

## AN INDUSTRY FIRST! AUTO IDLING STOP

### Reduces air pollution by cutting exhaust emissions

Auto Idling Stop eliminates wasteful and unnecessary engine idling. It cuts emissions of nitrogen oxide and carbon dioxide, minimizing the machine's effect on atmospheric pollution and global warming.



Auto Idling Stop (AIS) control switch

### Reduces fuel consumption by approx. 20% (KOBELCO comparisons)

A big boost to energy saving! Fuel consumption is cut by approx. 20% compared with conventional machines. Significant savings can be made on fuel costs.

Note: May vary, according to operating conditions.



#### AIS System

The AIS system is activated whenever the safety lock lever is pulled up.

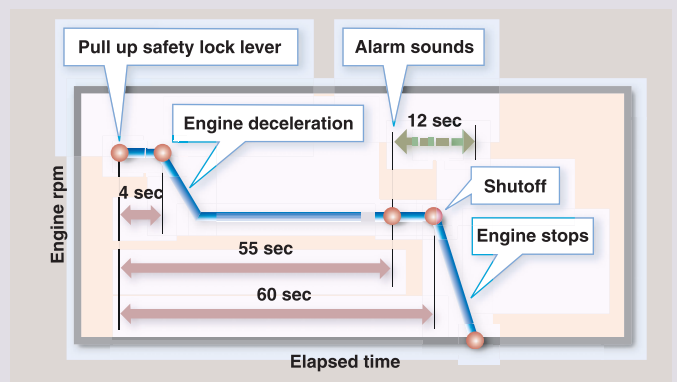

## World-Class Cab Offers Plenty of Comfortable Space



### Convenient Console Layout

- ① Electric rotary engine throttle
- ② Working mode selector switch
- ③ Multi-display monitor
- ④ Power Boost switch
- ⑤ Safety lever lock
- ⑥ Automatic climate control system

### Wide, Reinforced Cab

The cab is 1,005 mm wide, easily meeting European Standards. Comfort and ease of operation are the key words that describe the working environment, with reinforced pillars that provide added cab strength. Ample head clearance makes cab entry and exit easy.

### Panoramic Visibility!

The forward view from the operator's seat easily clears ISO Standards, with upward visibility enhanced by the skylight.



### New! Front Wiper Blade Covers 20% More Area

- "Rise-up" long wiper blade stores up out of view.
- Polycarbonate skylight lifts up easily with help of a gas spring.



### Automatic Climate Control

With a cooling output of 5.35 kW (4,600 kcal/h) and a heating output of 5.93 kW (5,100 kcal/h), the powerful climate control system keeps the cab comfortable in all kinds of weather. Just set the desired temperature.

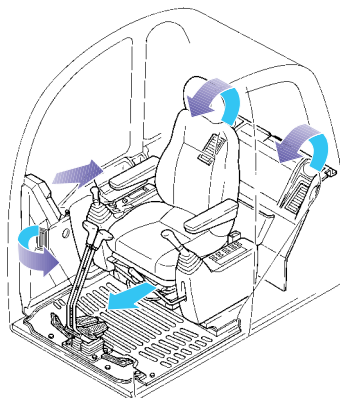

### Low Noise and Vibration

Viscous cab mounts effectively reduce vibration. Further protection against vibration and noise is provided by the high rigidity of the cab structure itself.

#### Cross-section of Viscous Cab Mount

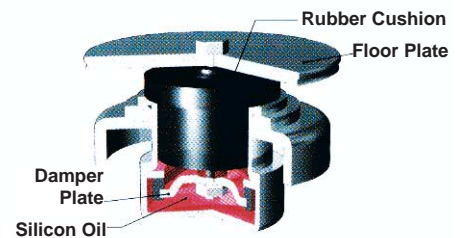

### Fully Adjustable Operator's Seat

The seat can be slid forward and backward either independently or together with the control console.



### Additional mirrors fitted to ensure on-site safety



Side mirror

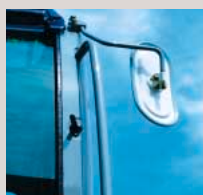

Cab side mirror

### Relaxing Amenities



- New cup holder
- Hot'n'Cool box and large-capacity luggage box
- Easy-open front window with assist mechanism
- Optional rain visor

# HIGH RELIABILITY

## Excellent Reliability and Maintenance Features Ensure an Extended High-Performance



### New CPU Back-up System

The chances of computer failure are very few, but if it happens, a new CPU back-up system keeps the engine and hydraulic system operating to allow the machine going at 90% normal capacity.



Engine cable throttle used when CPU is down



Emergency engine stop

#### CPU Back-up System

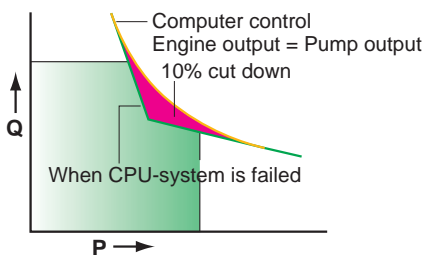

### Highly Durable Attachment Bushing

- The self-greasing bushing in the boom foot and cylinder fixtures prolong service interval.
- The boom foot fixation has been reinforced by the usage of special extra-hard bushings.
- New bucket-clatter adjustment mechanism improves durability.



self-greasing bushing



New bucket-clatter adjustment mechanism



### SUPER FINE FILTER, A LONG-LIFE FILTER FOR HYDRAULIC OIL

Filter life extended to 1,000 hours



Large capacity Super Fine Filter is made of high performance filter medium. It requires changing only once in 1,000 hours double the life of conventional filters. It saves on lifelong operating costs.

### New Removable Aluminium Radiator

The SK200/SK200LC MARK-VI SUPER has been equipped with a radiator made of aluminium and disperses heat very efficiently. The new design also allows you to remove the entire radiator for cleaning without detaching the hydraulic piping. To make routine cleaning easier, there is ample space between the radiator and the oil cooler.

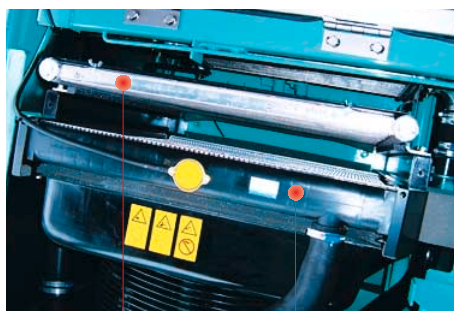

Aluminium oil cooler Aluminium radiator

### New Water Separator

Large capacity and transparent water separator can separate more water from the fuel for longer cleaning intervals and easier routine maintenance.



### Multi-Display Monitor



- The Multi-display Monitor constantly indicates the machine's running condition. The analog fuel and water temperature gauges can be read anytime at a glance.
- All frequently used switches are located on the display monitor panel for easy access.

**Maintenance Information Display**  
**Self-diagnostic function: 28 items**  
**Service diagnostic function: 23 items**  
**Malfunction log: 60 items**

## Environment Friendly and Safety Features

### For Environment

- New engine complies with Tier II (European) Regulations for Exhaust Emissions.
- Non Amin LLC, Bio oil (option)

### For Safety

Seatbelt, Safety lock lever, Handy hammer, Laminated safety glass, Safety valves for boom cylinders and arm cylinder(option), Travel alarm(option)

# SPECIFICATIONS



## ENGINE

<b>Model:</b>	Mitsubishi 6D34-TLE2A
<b>Type:</b>	Direct injection, water-cooled, 4-cycle diesel engine with turbocharger, intercooler (Comply with Tier II Regulation: Europe)
<b>No. of cylinders:</b>	6
<b>Bore and stroke:</b>	104 mm × 115 mm
<b>Displacement:</b>	5,861 cc
<b>Rated power output:</b>	150 PS (148 HP) NET at 2,000 min <sup>-1</sup> (rpm) (SAE J1349) 110 kW NET at 2,000 min <sup>-1</sup> (rpm) (ISO 9249)
<b>Max. torque:</b>	59.0 kg•m NET at 1,500 min <sup>-1</sup> (rpm) (SAE J1349) 580 N•m NET at 1,500 min <sup>-1</sup> (rpm) (ISO 9249)



## HYDRAULIC SYSTEM

<b>Pump:</b>	Two variable displacement pumps + 1 gear pump
<b>Max. discharge flow:</b>	2 × 210 liter/min
<b>Max. discharge pressure:</b>	
<b>Boom, arm and bucket:</b>	34.3 MPa (350 kgf/cm <sup>2</sup> )
<b>Power Boost:</b>	37.8 MPa (385 kgf/cm <sup>2</sup> )
<b>Travel circuit:</b>	34.3 MPa (350 kgf/cm <sup>2</sup> )
<b>Swing circuit:</b>	27.9 MPa (285 kgf/cm <sup>2</sup> )
<b>Control circuit:</b>	5.0 MPa (50 kgf/cm <sup>2</sup> )
<b>Pilot control pump:</b>	Gear type
<b>Main control valves:</b>	6-spool
<b>Oil cooler:</b>	Finned tube, forced ventilation



## CAB & CONTROL

All-weather, sound-suppressed steel cab is mounted on the silicon-sealed viscous mounts and equipped with a heavy, insulated floor mat. Large, tinted safety-glass windows, with pull-type upper front window and removable lower front window. Four-way adjustable dual-slide seat, electric rotary-type engine throttle, safety-lock lever, and easy-to-read multi-display monitor. Ventilated, pressurized climate control system that brings fresh air into cab. Intermittent windshield wiper with two-jet washer, skylight, ashtray, cigarette lighter, cab light (interior), coat hook, and utility box.



## ATTACHMENTS

Backhoe bucket and arm combination

Use	Backhoe bucket								Slope finishing bucket	
	Normal digging				Light-duty		Heavy digging			
Bucket capacity	m <sup>3</sup>	0.51	0.70	0.80	0.93	1.05	1.30	0.80	—	
Bucket capacity (CECE heaped)	m <sup>3</sup>	0.45	0.61	0.70	0.80	0.90	1.10	0.70	—	
Opening width or X-section	With side cutters	mm	870	1,080	1,160	1,330	1,460	—	1,150	—
	Without side cutters	mm	770	980	1,060	1,230	1,360	1,630	1,060	2,200 × 1,100
No. of bucket teeth		3	5	5	5	6	6	4	—	
Combinations	2.40 m arm		○	○	○	○	△	△	○	△
	2.94 m arm		○	○	○	△	×	×	○	△
	3.50 m arm		○	○	△	×	×	×	×	△

○ Recommended △ Loading only × Not recommended



## TRAVEL SYSTEM

<b>Travel motors:</b>	Independent, axial-piston, two-step motors
<b>Brakes:</b>	Hydraulic disc brakes
<b>Track shoes:</b>	46 each side (SK200) 49 each side (SK200LC)
<b>Travel speed:</b>	6.0/4.0 km/h
<b>Drawbar pulling force:</b>	199 kN (20,300 kgf)-SAE J1309 MAY91
<b>Gradeability:</b>	35° (70 %)
<b>Ground clearance:</b>	450 mm



## SWING SYSTEM

<b>Brake:</b>	Hydraulic; locking automatically when the swing control lever is in the neutral position
<b>Parking brake:</b>	Hydraulic disc brake
<b>Swing speed:</b>	11.0 rpm
<b>Tail swing radius:</b>	2,750 mm
<b>Min. front swing radius:</b>	3,560 mm



## BOOM, ARM AND BUCKET

<b>Boom cylinders :</b>	125 mm × 1,240 mm
<b>Arm cylinder:</b>	135 mm × 1,490 mm
<b>Bucket cylinder:</b>	120 mm × 1,080 mm



## REFILLING CAPACITIES AND LUBRICATIONS

<b>Fuel tank:</b>	340 liter
<b>Cooling system:</b>	19 liter
<b>Engine oil:</b>	24 liter
<b>Travel reduction gear:</b>	2 × 5.5 liter
<b>Swing reduction gear:</b>	7.5 liter
<b>Hydraulic oil tank:</b>	156 liter
<b>Hydraulic system:</b>	246 liter





## WORKING RANGES

Range	Arm	Short 2.40 m	Standard 2.94 m	Long 3.5 m
a- Max. digging reach		9.42	9.90	10.30
b- Max. digging reach at ground level		9.25	9.75	10.15
c- Max. digging depth		6.16	6.70	7.26
c'- Max. depth of bucket hinge pin		4.72	5.26	5.82
d- Max. digging height		9.38	9.60	9.52
d'- Max. height of bucket hinge pin		8.00	8.23	8.20
e- Max. dumping clearance		6.56	6.79	6.76
f- Min. dumping clearance		2.87	2.33	1.77
g- Max. vertical wall digging depth		5.50	6.04	6.33
h- Min. swing radius		3.55	3.56	3.56
i- Horizontal digging stroke at ground level.		4.08	5.27	6.02
j- Digging depth for 2.4 m (8') flat bottom		5.96	6.53	7.08
Bucket capacity SAE heaped m <sup>3</sup>		0.93	0.80	0.70

### Digging Force (ISO 6015)

Unit: kN (kgf)

Arm length	Short 2.40 m	Standard 2.94 m	Long 3.5 m
Bucket digging force	143 (14,600) 157 (16,000)*	143 (14,600) 157 (16,000)*	143 (14,600)
Arm crowding force	116 (11,800) 127 (12,900)*	97.1 (9,900) 107 (10,900)*	85.9 (8,760)

\*Power Boost engaged.

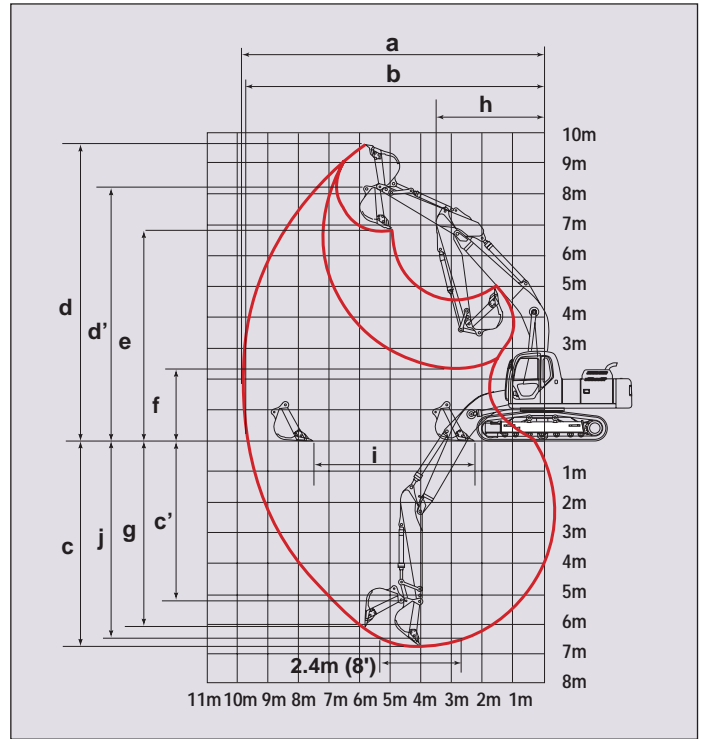

## DIMENSIONS

Arm length	Short 2.40 m	Standard 2.94 m	Long 3.5 m
A Overall length	9,480	9,410	9,470
B Overall height (to top of boom)	3,110	2,930	3,170
C Overall width	SK200	2,800	2,800
	SK200LC	2,990	2,990
D Overall height (to top of cab)	2,930	2,930	2,930
E Ground clearance of rear end*	1,060	1,060	1,060
F Ground clearance*	450	450	450
G Tail swing radius	2,750	2,750	2,750

		Unit: mm		
G'	Distance from center of swing to rear end	2,730	2,730	2,730
H	Tumbler distance	SK200	3,370	3,370
		SK200LC	3,660	3,660
I	Overall length of crawler	SK200	4,170	4,170
		SK200LC	4,450	4,450
J	Track gauge	SK200	2,200	2,200
		SK200LC	2,390	2,390
K	Shoe width	600/700/800		
L	Overall width of upperstructure	2,710	2,710	2,710

\* Without including height of shoe lug.

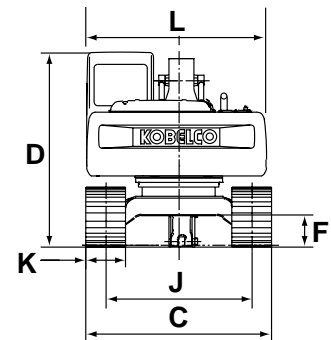
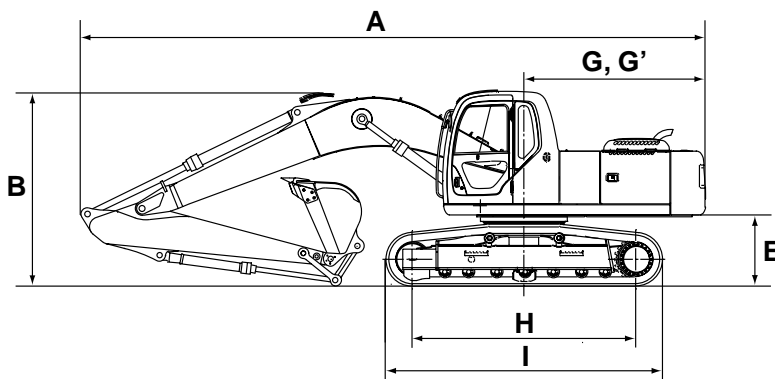

## OPERATING WEIGHT AND GROUND PRESSURE

In standard trim, with standard boom, 2.94 m arm, and 0.8 m<sup>3</sup> SAE heaped bucket

Shaped		Triple grouser shoes (even height)		
Shoe width	mm	600	700	800
Overall width	mm	SK200	2,800	3,000
		SK200LC	2,990	3,190
Ground pressure	kPa (kgf/cm <sup>2</sup> )	SK200	45 (0.46)	35 (0.35)
		SK200LC	42 (0.43)	33 (0.33)
Operating weight	kg	SK200	20,000	20,700
		SK200LC	20,400	21,100

# SK200/SK200<sub>LC</sub> MARK-VI SUPER

## LIFTING CAPACITIES

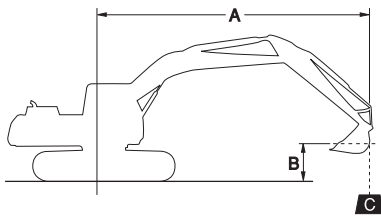

Rating over front



Rating over side or 360 degrees

A - Reach from swing centerline to bucket hook

B - Bucket hook height above/below ground

C - Lifting capacities in kilograms











• Max. discharge pressure: 37.8 MPa (385 kg/cm<sup>2</sup>)











		SK200 Standard Arm: 2.94 m Bucket: 0.80 m <sup>3</sup> SAE heaped 650 kg Shoe: 600 mm									
		1.5 m		3.0 m		4.5 m		6.0 m		7.5 m	
B	A										
4.5 m	kg							*4,920	4,300	*4,200	2,900
3.0 m	kg			*11,390	*11,390	*7,320	6,410	*5,770	4,050	4,400	2,790
1.5 m	kg			*6,660	*6,660	*9,110	5,870	6,090	3,800	4,260	2,660
G. L.	kg			*7,180	*7,180	9,350	5,530	5,870	3,600	4,140	2,550
-1.5 m	kg	*6,240	*6,240	*10,050	*10,050	9,200	5,410	5,760	3,510	4,090	2,500
-3.0 m	kg	*9,550	*9,550	*14,290	10,660	9,230	5,430	5,770	3,510		
-4.5 m	kg			*11,610	10,980	*8,170	5,590				











		SK200 Standard Arm: 2.94 m Bucket: 0.80 m <sup>3</sup> SAE heaped 650 kg Shoe: 800 mm									
		1.5 m		3.0 m		4.5 m		6.0 m		7.5 m	
B	A										
4.5 m	kg							*4,920	4,430	*4,200	3,000
3.0 m	kg			*11,390	*11,390	*7,320	6,590	*5,770	4,180	4,540	2,880
1.5 m	kg			*6,660	*6,660	*9,110	6,050	6,280	3,920	4,400	2,750
G. L.	kg			*7,180	*7,180	9,660	5,710	6,070	3,730	4,290	2,650
-1.5 m	kg	*6,240	*6,240	*10,050	*10,050	9,510	5,590	5,960	3,630	4,240	2,600
-3.0 m	kg	*9,550	*9,550	*14,290	10,990	9,530	5,610	5,960	3,630		
-4.5 m	kg			*11,610	11,310	*8,170	5,770				











		SK200 Long Arm: 3.50 m Bucket: 0.68 m <sup>3</sup> (SAE heaped) 630 kg Shoe: 600 mm									
		1.5 m		3.0 m		4.5 m		6.0 m		7.5 m	
B	A										
6.0 m	kg									*3,300	3,010
4.5 m	kg							*5,010	4,360	4,560	2,930
3.0 m	kg					*7,370	6,530	*6,000	4,090	4,410	2,790
1.5 m	kg			*11,860	11,180	*9,550	5,930	6,100	3,800	4,250	2,640
G. L.	kg	*3,920	*3,920	*9,320	*9,320	9,340	5,510	5,850	3,570	4,110	2,510
-1.5 m	kg	*6,810	*6,810	*11,320	10,330	9,120	5,320	5,700	3,440	4,030	2,440
-3.0 m	kg	*9,860	*9,860	*14,930	10,410	9,090	5,300	5,660	3,410		
-4.5 m	kg	*13,520	*13,520	*14,380	10,670	9,230	5,420	5,760	3,500		

		SK200 Long Arm: 3.50 m Bucket: 0.68 m <sup>3</sup> (SAE heaped) 630 kg Shoe: 800 mm									
		1.5 m		3.0 m		4.5 m		6.0 m		7.5 m	
B	A										
6.0 m	kg									*3,300	3,100
4.5 m	kg							*5,010	4,480	*4,570	3,020
3.0 m	kg					*7,370	6,710	*6,000	4,220	4,560	2,890
1.5 m	kg			*11,860	11,510	*9,550	6,110	6,310	3,930	4,400	2,740
G. L.	kg	*3,920	*3,920	*9,320	*9,320	9,660	5,690	6,050	3,700	4,260	2,610
-1.5 m	kg	*6,810	*6,810	*11,320	10,660	9,430	5,500	5,900	3,560	4,180	2,530
-3.0 m	kg	*9,860	*9,860	*14,930	10,740	9,410	5,480	5,870	3,530		
-4.5 m	kg	*13,520	*13,520	*14,380	11,000	9,540	5,600	5,970	3,620		

		SK200LC Standard Arm: 2.94 m Bucket: 0.80 m <sup>3</sup> SAE heaped 650 kg Shoe: 600 mm									
A \ B		1.5 m		3.0 m		4.5 m		6.0 m		7.5 m	
											
4.5 m	kg							*4,920	4,790	*4,200	3,250
3.0 m	kg			*11,390	*11,390	*7,320	7,180	*5,770	4,540	4,990	3,130
1.5 m	kg			*6,660	*6,660	*9,110	6,630	*6,660	4,270	4,850	3,000
G. L.	kg			*7,180	*7,180	*10,210	6,280	6,730	4,080	4,730	2,890
-1.5 m	kg	*6,240	*6,240	*10,050	*10,050	*10,440	6,150	6,610	3,980	4,680	2,840
-3.0 m	kg	*9,550	*9,550	*14,290	12,360	*9,840	6,180	6,620	3,980		
-4.5 m	kg			*11,610	*11,610	*8,170	6,350				

		SK200LC Standard Arm: 2.94 m Bucket: 0.80 m <sup>3</sup> SAE heaped 650 kg Shoe: 800 mm									
A \ B		1.5 m		3.0 m		4.5 m		6.0 m		7.5 m	
											
4.5 m	kg							*4,920	*4,920	*4,200	3,360
3.0 m	kg			*11,390	*11,390	*7,320	*7,320	*5,770	4,680	*5,000	3,240
1.5 m	kg			*6,660	*6,660	*9,110	6,840	*6,660	4,420	5,020	3,110
G. L.	kg			*7,180	*7,180	*10,210	6,500	6,960	4,220	4,900	3,010
-1.5 m	kg	*6,240	*6,240	*10,050	*10,050	*10,440	6,370	6,850	4,120	4,850	2,960
-3.0 m	kg	*9,550	*9,550	*14,290	12,760	*9,840	6,390	6,850	4,130		
-4.5 m	kg			*11,610	*11,610	*8,170	6,560				

		SK200LC Long Arm: 3.50 m Bucket: 0.68 m <sup>3</sup> (SAE heaped) 630 kg Shoe: 600 mm									
A \ B		1.5 m		3.0 m		4.5 m		6.0 m		7.5 m	
											
6.0 m	kg									*3,300	*3,300
4.5 m	kg							*5,010	4,850	*4,570	3,280
3.0 m	kg					*7,370	7,310	*6,000	4,570	5,010	3,140
1.5 m	kg			*11,860	*11,860	*9,550	6,690	6,970	4,280	4,840	2,990
G. L.	kg	*3,920	*3,920	*9,320	*9,320	10,870	6,270	6,700	4,050	4,700	2,860
-1.5 m	kg	*6,810	*6,810	*11,320	*11,320	10,630	6,070	6,550	3,910	4,610	2,780
-3.0 m	kg	*9,860	*9,860	*14,930	12,100	10,600	6,040	6,510	3,880		
-4.5 m	kg	*13,520	*13,520	*14,380	12,370	*9,940	6,160	6,620	3,970		

		SK200LC Long Arm: 3.50 m Bucket: 0.68 m <sup>3</sup> (SAE heaped) 630 kg Shoe: 800 mm									
A \ B		1.5 m		3.0 m		4.5 m		6.0 m		7.5 m	
											
6.0 m	kg									*3,300	*3,300
4.5 m	kg							*5,010	5,000	*4,570	3,390
3.0 m	kg					*7,370	*7,370	*6,000	4,720	5,190	3,250
1.5 m	kg			*11,860	*11,860	*9,550	6,910	*7,090	4,430	5,020	3,100
G. L.	kg	*3,920	*3,920	*9,320	*9,320	*11,070	6,480	6,950	4,190	4,880	2,970
-1.5 m	kg	*6,810	*6,810	*11,320	*11,320	11,010	6,280	6,790	4,060	4,790	2,890
-3.0 m	kg	*9,860	*9,860	*14,930	12,500	10,980	6,260	6,760	4,030		
-4.5 m	kg	*13,520	*13,520	*14,380	12,780	*9,940	6,380	6,860	4,120		

**Notes:**

- Do not attempt to lift or hold any load that exceeds these rated values at their specified load radii and heights.
- Lifting capacities assume a machine standing on a level, firm, and uniform supporting surface. Operator must make allowance for job conditions such as soft or uneven ground, out of level conditions, side loads, sudden stopping of loads, hazardous conditions, inexperienced personnel, weight of various other buckets, lifting slings, attachments, etc.
- Ratings at bucket lift hook.

- The above rated loads are in compliance with SAE Hydraulic Lift Capacity Rating Standard J 1097. They do not exceed 87% of hydraulic lifting capacity or 75% of tipping load. Rated loads marked with an asterisk(\*) are limited by hydraulic capacity rather than tipping load.
- Operator should be fully acquainted with the operators' manual before operating this machine. Rules for safe operation of equipment should be followed at all times.
- Capacities apply only to the machine as originally manufactured and normally equipped by KOBELCO Construction Machinery Co., Ltd.

## STANDARD EQUIPMENT

- Engine, MITSUBISHI 6D34-TLE2A, turbocharger, intercooler
- Working mode selector (Assist mode, Manual mode, or Breaker mode)
- Power Boost
- Swing rebound prevention system
- Sequenced arm regeneration system
- Straight travel system
- Automatic shift down two-speed travel
- Automatic engine deceleration
- Auto Idling Stop (AIS)
- Sealed and lubricated tracks
- Batteries (2 × 12V - 96Ah)
- Starting motor (24V - 5 kW), 35 amp alternator
- Easy removable aluminium radiator
- Large capacity water separator
- Towing eyes
- Aluminium hydraulic oil cooler
- Double element air cleaner
- Automatic engine shut-down at low engine oil pressure
- Horn, electric
- Two side mirrors
- One front and two rear working lights
- Swing flashers
- Automatic swing brake
- Two control levers, pilot-operated









- Cab, all-weather sound suppressed type with ashtray, cigarette lighter, cab light (interior), coat hook, floor mat, 4-way adjustable seat, retractable seatbelt, head rest, hand rails, heater and defroster, intermittent windshield wiper with double-spray washer, sunshade, skylight, tinted safety glass, pull-type front window and removable lower front window
- Instrument panel: Easy-to-read multi-display monitor
- Automatic climate control

## OPTIONAL EQUIPMENT

- Radio, AM/FM Stereo with speakers
- Wide range of buckets
- Various optional arms
- Wide range of shoes
- Travel alarm
- Boom safety valves
- Arm safety valve
- Front guard protective structures
- Additional hydraulic circuit
- FOPS-compliant head guard

*Note: Standard and optional equipment may vary. Consult your KOBELCO dealer for specifics.*

## Little Details Make a Big Difference...

 <p><b>Large-size battery box</b></p>	 <p><b>Easy-to-clean floor mat</b></p>	 <p>Insulating plate prevents hydraulic oil from splattering on the engine and the muffler.</p>
 <p><b>Sunshade protects the operator from overhead sunlight</b></p>	 <p><b>FOPS-Compliant Head Guard (Option)</b> The cab clears ISO-rated FOPS Standards. Equipped with the optional extra-strength head guard.</p>	 <p>Finish with round trim at the front of cab for quality appearance.</p>
 <p>Thermal guard prevents contact with hot components.</p>	 <p>Hammer to break glass in case of emergency.</p>	 <p><b>Hot 'n' Cool Box</b> Hot 'n' Cool Box for snacks and drinks.</p>

Note: This catalog may contain attachments and optional equipment that are not available in your area. And it may contain photographs of machines with specifications that differ from those of machines sold in your areas. Please consult your nearest KOBELCO distributor for those items you require. Due to our policy of continuous product improvements all designs and specifications are subject to change without advance notice.

Copyright by **KOBELCO CONSTRUCTION MACHINERY CO., LTD.** No part of this catalog may reproduce in any manner without notice.

### KOBELCO CONSTRUCTION MACHINERY CO., LTD.

17-1, Higashigotanda 2-chome, Shinagawa-ku, Tokyo 141-8626 JAPAN  
Tel: ++81 (0) 3-5789-2126 Fax: ++81 (0) 3-5789-2134

### KOBELCO INTERNATIONAL (S) CO., PTE, LTD.

60 Pandan Road, Jurong, Singapore 609294  
TEL: 65-6268-8200 FAX: 65-6268-2490

Inquiries To: