

**CPCD 120-160** G series Balance Weight Type Forklift



**HELI**

**12-16 t**

G Series Balance Weight Type Forklift

**STAGE V**



# Our Strength



Anhui Heli Co. Ltd. , a core holding subsidiary of the forklift group, was listed in Shanghai Stock Exchange in 1996 and it is registered capital is 616.8 million. It is presently an industrial vehicle research and development, manufacturing and export base in China with large scale, complete product line and industrial chain and strong overall strength.

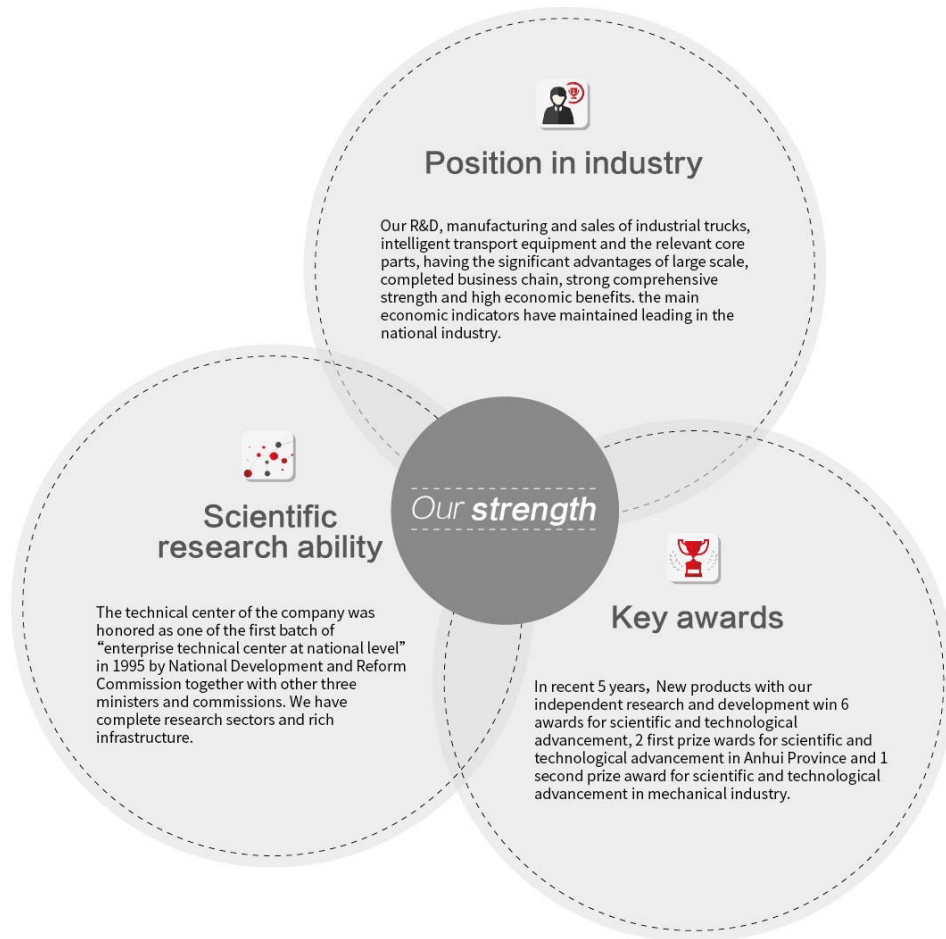

## HELIX around the world

HELIX ranked top 10 among the world industrial truck sector in 2006 and top 8 from 2011. HELIX has autonomous sales network and sound service system with 24 provincial sales network and more than 400 second level dealers in domestic and in overseas, HELIX sets up sales network in more than 80 countries and regions and our products sell to 150 countries and regions over the world In the next five years, Heli will vigorously promote the international operation and create a global famous brand.

## Brand concept

With being world top 5 as the short-term goal, HELIX is committed to be a world advanced and over-lasting enterprise. Centennial HELIX is our definition in thought and world top 5 is our quantized goal. HELIX people work steadily and keep forging ahead to make our enterprise bigger and stronger. HELIX has gone to a fast developing time since the new century. In 2006, HELIX ranked world top 10. Now, we make our decision to be world top 5 which is not only a heritage of our glorious history but also our never-ending hard effort.

## Heavy machine manufacturing base

Based on HELIX strong scientific research platform and manufacturing ability, HELIX research and develop, produce and sale heavy trucks, reach stacker and empty container handler with completed series and various types to provide customers with special material handling solutions.  
 Heavy truck: 12t-18t, 20-25t, 28-32t, 35t, 38-40t, 42-46t  
 Reach stacker: standard type reach stacker, heavy type reach stacker  
 Container handler :2-3 layer, 5-6 layer, 7-8 layer

# A Enduring and durable

## A.1 Durable structure design

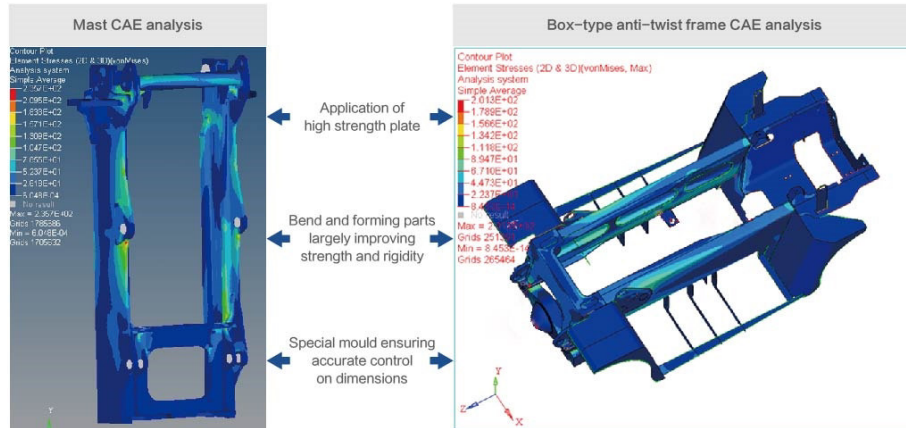

## A.2 Easy and high efficient daily inspection

- ▶ **Cab electric tilting system**  
Automatic tilting system facilitates interior maintenance; Hydraulic drives tilting cylinder with electric assistance making cab tilt 60° right ward which makes maintenance easy.
- ▶ **Engine hood with large opening angle**  
Open type engine hood which can be open through two self-lock spring ensures easy and high efficient maintenance.



### ▶ Easy liquid adding and check

Cooling liquid adding and check, fuel adding, level check, oil-water separator replacement, engine oil adding and check and hydraulic oil level check become easier.



- Easy cooling liquid adding and check
- Easy fuel adding and check
- Easy hydraulic oil level and quality (hydraulic oil level gauge)
- Easy oil-water separator replacement and maintenance
- Easy engine oil adding and check



A.3 Improved protection performance

- ▶ Oil cylinder protection sleeve
- ▶ Electric tilting button with high dust-proof and water-proof degree
- ▶ Improved harness protection degree
- ▶ Dust-proof and water-proof plus and sockets
- ▶ Dust-proof vent
- ▶ High strength aluminum plate fin type radiator
- ▶ Improved fuel pipe safety degree



■ Oil cylinder protection sleeve(optional): it is used to protect cylinder damaged from foreign matters



■ Electric tilting button with high dust-proof and water-proof degree: protecting degree:IP67



■ Front axle dust proof vent



■ Transmission box dust proof vent



■ High strength fin type structure will not deform or crack easily.  
Exterior injection molding treatment---anti-corrosion and oxidation resistance.



■ Dust-proof sleeve for electric cabinet



■ Molding steel pipe is used for oil suction pipe improving safety degree largely.

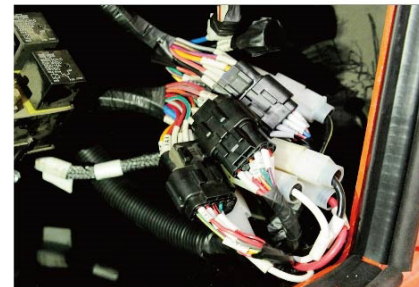

■ Dust proof and water proof sockets and plugs: protection degree IP65



■ Harness meets German standard and its temperature resistance ability is largely improved (-40°C-105°C).

**A.4 Improved cooling efficiency**

- ▶ Optimal designed channel
- ▶ Reasonable layout of radiator's fins
- ▶ Optimal designed fan



- **Optimal designed channel**  
Optimal designed radiator and channel make cooling system have small resistance, avoid air flowing back effectively and improve cooling efficiency.
- **Optimal designed fan**  
Axial fan with multiple blade, enough blast capacity and pressure and consume power is special for G series based on a large number of comparative tests.



**B/ Energy saving and environment friendly**

**B.1 High efficient matching, forceful power**

- ▶ **Cummins QSB6.7 engine**  
Six cylinder four stroke turbocharged engine which is powerful, reliable, and economic and meets EU Stage V/T4F/China Stage IV is assembled on the truck.
- ▶ **ZF transmission box**  
Smooth gear shifting without shock.  
Intelligent gear shifting mode is easier.  
High efficient power match is more energy saving.

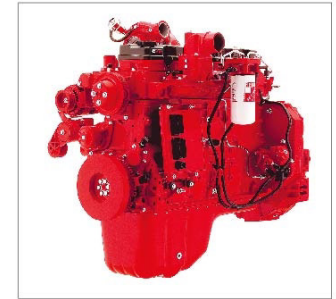

**B.2 Hydraulic dynamic load variable control system**

- ▶ It can adjust oil pump displacement automatically according to operator habit and load condition to achieve high precision flow control and energy saving.

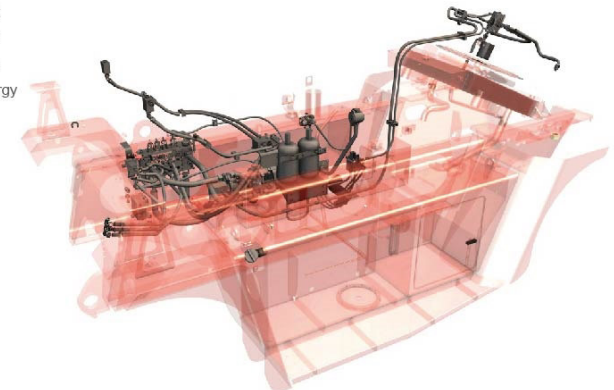

### B.3 Intelligent sensitive thermal management system

- ▶ Four in one compound radiator effectively integrates resource and saves space.
- ▶ Real time thermal managing system monitors cooling medium temperature curve of the completed truck and fan multilevel speed changing is achieved.
- ▶ The truck is heated quickly in winter and in summer, the system power consumption is more reasonable.
- ▶ The system saves 10% of the energy and consumption in low temperature area is 15% reduced.
- ▶ Better matching design, multilevel fan speed, outstanding noise reducing effect.



#### Intelligent sensitive thermal management system

- Electric control system  
Real time thermal managing system monitors cooling medium temperature curve of the completed truck to control fan speed.
- Hydraulic system  
Fan is powered by separated power which is different from traditional direct connection fan to achieve fan multilevel speed changing.
- Cooling system  
Four in one compound radiator, optimized air channel and fan the air duct and the fan.

### B.4 Light type design

- ▶ Rear counter weight has no air channel and counter weight use ratio is 5% increased and thus truck service weight is reduced.
- ▶ Light type design optimizes structure and the truck is lighter and more stable.



- Counter weight no air channel design  
Special cooling system layout and temperature control system are adopted on G series truck. rear counter weight has no air channel and counter weight use ratio is increased and thus truck service weight is reduced.
- Light type design
  - Application of high strength material.
  - Years of data accumulation and accurate CAE analysis.
  - Constant structure optimization.



# C Comfort and convenient



## C.1 Easy get on-off

- Large getting on off pedal and handrail  
Open type steps make easy and safe get on-off.
- Anti-skid pedal  
Anti-skid aluminous pedal has good anti-skid performance.
- Auxiliary handrail  
Solid and durable

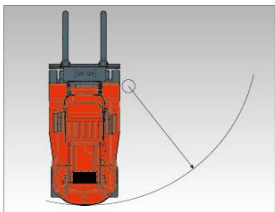

## C.2 Smaller turning radius

- Smaller turning radius  
Compact frame design  
Optimized steering angle



## C.3 Mast lower buffering

- Mast lower buffering  
Reduce the shock when lowering



## C.4 Superior view

- Superior front view  
Front glass with large arc is used and front view field angle is 10° increased.
- Superior top view  
Large glass is used on the top of cab.
- Superior rear view  
1200mmx900mm glass is used at the rear end of cab.
- Glass for left and right side window  
4 pieces of glass is used on left and right door to ensure 360° view.
- Professional ergonomics view analysis



- Rear vision system  
truck real time rear view can be displayed when backward.

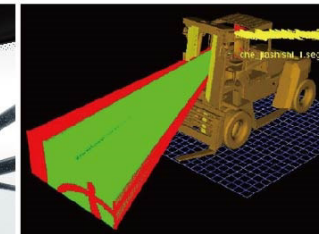

- Front view check

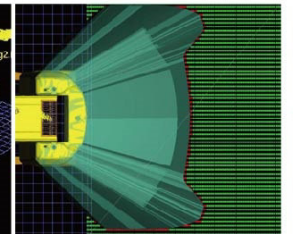

- Rear view check



**C.5 More comfort driving experience**

special cab with 360° view

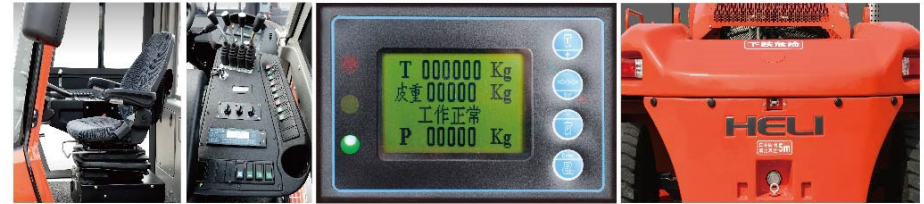
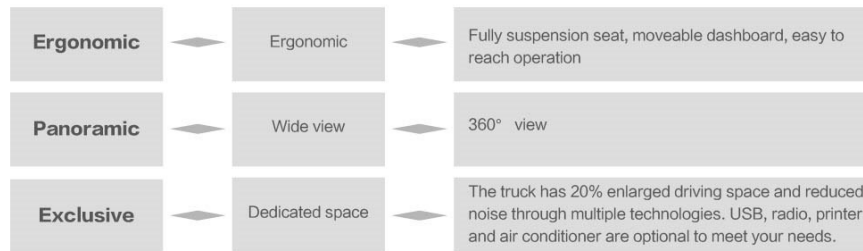

- **Moveable dashboard**  
Most reasonable relative position is set between dashboard and seat SIP point through optimized ergonomic and multiple test. Dashboard and seat can be moved together to meet different driving needs.
- **Weighting system(optional)**  
Weight can be measured accurately through checking hydraulic pressure.
- **Backward radar**  
Monitor is achieved through reasonable distributed 6 points. Larger monitoring range



- **Fully suspension seat**  
Adjustable damping shock reducing design not only bears your weight but also provides steady driving experience.
- **Adjustable steering wheel**  
Steering wheel can be adjusted according to operator habit and easy and flexible steering largely reduces your work.
- **Pedal optimized layout**  
Optimized pedal reduces fatigue during long time working.



- **Temperature control system through multiple channel**  
Fully sealed cab controls temperature in the cab high efficiently and multiple channels cross ventilation keep the temperature in the cab stable. winter.
- **Flexible control knob**  
Accurate, safe and effective control can be achieved through small operation force.



## D Safe and high efficient



### D.1 Better stability

- ▶ Smaller front overhang
  - More compact mast structure
- ▶ Retroposition of center of gravity
  - Retroposition of power system
  - Retroposition of cooling system
  - No air channel on the balance weight

### D.2 OPS

- ▶ OPS for the whole truck
  - Truck power will be cut automatically and the truck can not be operated when operator is away from seat.
- ▶ OPS system for mast
  - The mast is locked and can not be operated when operator is away from seat.



**D.3 Wet type drive axle**



► **Maintenance free**

Specially designed structure and brake principle provides anti-dust and anti-water function and saves your maintenance cost.

► **Safe and reliable brake**

Working requirements such as Long time, high duty, short distance or frequent brake can be satisfied.

**D.4 High efficient working**



► **High efficient operation**

- Hydraulic pilot long distance control provide high operation accuracy and quick response.
- Integrated dashboard makes operation easy.
- Reasonable ergonomics layout provides you human-machine friendly operating experience.

► **High efficient performance**

- Faster working speed
- Better gradeability
- Forceful power output provides truck better acceleration performance and gradeability.

Most lifting and lowering speed is 5% increased.



# E Technical parameters

Technical parameters												
01	Model	Unit	CPCD120-C2Z-09	CPCD135-C2Z-06	CPCD150-C2Z-06	CPCD160-C2Z-06	CPCD140-C2Z-09	CPCD150-C2Z-09	CPCD160-C2Z-09	CPCD140-C2Z-12	CPCD150-C2Z-12	CPCD160-C2Z-12
02	Rated load	t	12	13.5	15	16	14	15	16	14	15	16
03	The mass	kg	17800	17800	18400	18800	20500	21000	21500	21400	22200	23000
04	Maximum lifting speed (loaded/unloaded)	mm/s	360/380	360/380	350/380	350/380	370/400	370/400	370/400	370/400	370/400	370/400
05	Maximum speed (loaded/unloaded)	km/h	24/26	24/26	25/27	25/27	26/27	26/27	26/27	27/28	26/27	24/26
06	Gradeability (loaded/unloaded) ( 3km/h )	%	25/25	25/25	25/25	25/25	25/25	25/25	25/25	25/25	25/25	25/25

Size parameters												
01	Model	Unit	CPCD120-C2Z-09	CPCD135-C2Z-06	CPCD150-C2Z-06	CPCD160-C2Z-06	CPCD140-C2Z-09	CPCD150-C2Z-09	CPCD160-C2Z-09	CPCD140-C2Z-12	CPCD150-C2Z-12	CPCD160-C2Z-12
02	Overall length	L	6705	6255	6265	6265	7105	7105	7105	7975	7975	7975
03	Overall width	W	mm	2560	2560	2560	2560	2560	2560	2560	2560	2560
04	Overall height	H	mm	3410	3410	3425	3425	3340	3340	3340	3340	3340
05	Load center distance	L1	mm	900	600	600	600	900	900	1200	1200	1200
06	Wheelbase	L2	mm	3250	3250	3250	3250	3500	3500	3500	3750	3750
07	Front overhang	L3	mm	785	785	795	795	925	925	925	930	930
08	Rear overhang	L4	mm	850	850	850	850	850	850	850	850	850
09	Minimum underground clearance	H2	mm	285	285	285	285	285	285	285	285	285
10	Seat height	H4	mm	1970	1970	1985	1985	1985	1985	1985	1985	1985
11	Turning radius (inside)	R1	mm	220	220	220	220	220	220	220	220	220
12	Turning radius (outside)	R2	mm	4450	4450	4500	4500	4750	4750	4750	5100	5100
13	Front track	W1	mm	1888	1888	1888	1888	1895	1895	1895	1895	1895
14	Rear track	W2	mm	2120	2120	2120	2120	2120	2120	2120	2120	2120
15	Mast height (retracted/extended)	H/H1	mm	3410/4910	3410/4910	3425/4925	3425/4925	3340/4840	3340/4840	3340/4840	3340/4840	3340/4840
16	Mast lifting height	H3	mm	3000	3000	3000	3000	3000	3000	3000	3000	3000
17	Mast tilting angle (forward/backward)	$\alpha / \beta$	deg	6/12	6/12	6/12	6/12	6/12	6/12	6/12	6/12	6/12
18	Fork dimension (length*width*thickness)	mm	1820 × 200 × 85	1370 × 200 × 85	1370 × 200 × 85	1370 × 200 × 85	1820 × 200 × 95	1820 × 200 × 95	1820 × 200 × 95	2440x200x100	2440x200x100	2440x200x100
19	Fork adjusting range	mm	500-2370	500-2370	500-2370	500-2370	610-2150	610-2150	610-2150	610-2150	610-2150	610-2150

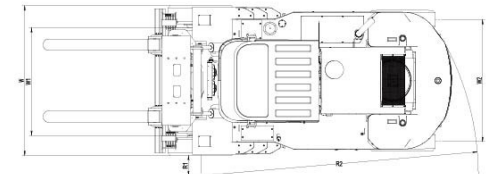
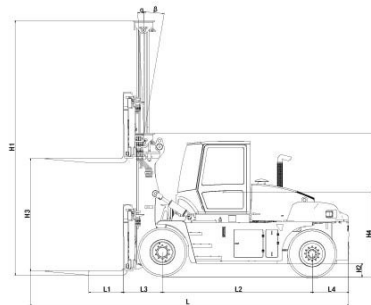
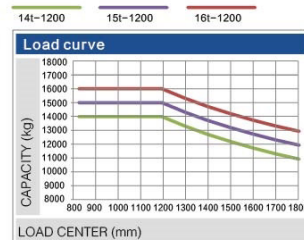
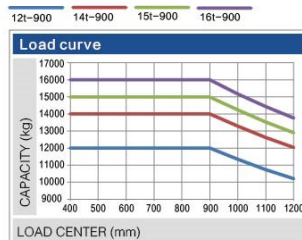
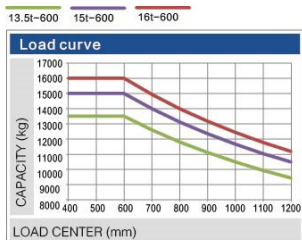



G Series 12–13.5t forklift truck (ultimate version)–Standard Mast

Mast model	Max.lifting height (mm)	Load capacity (lode center 900mm)(kg)		Overall height of mast (mm)	Max.mast height(mm)	Mast tilt angle $\alpha/\beta$ (°)
		CPCD120	CPCD135			
M300	3000	12000	13500	3410	4910	6/12
M350	3500	12000	13500	3480	5230	6/12
M400	4000	12000	13500	3730	5730	6/12
M450	4500	12000	13500	3980	6230	6/12
M500	5000	12000	13500	4280	6780	6/6
M550	5500	11000	12500	4530	7280	3/6
M600	6000	10000	11500	4830	7830	3/6
M650	6500	9000	10500	5080	8330	3/6

G Series 15–16t light type forklift truck (ultimate version) –Standard Mast

Mast model	Max.lifting height (mm)	Load capacity (lode center 600mm)(kg)		Overall height of mast (mm)	Max.mast height(mm)	Mast tilt angle $\alpha/\beta$ (°)
		CPCD150	CPCD160			
M300	3000	15000	16000	3425	4925	6/12
M350	3500	15000	16000	3495	5245	6/12
M400	4000	15000	16000	3745	5745	6/12
M450	4500	15000	16000	3995	6245	6/12
M500	5000	15000	16000	4295	6795	6/6
M550	5500	14000	15000	4545	7295	3/6
M600	6000	13000	14000	4845	7845	3/6
M650	6500	12000	13000	5095	8345	3/6

G Series 14–16t standard type forklift truck (ultimate version)–Standard Mast

Mast model	Max.lifting height (mm)	Load capacity (lode center 900mm)(kg)			Overall height of mast (mm)	Max.mast height(mm)	Mast tilt angle $\alpha/\beta$ (°)
		CPCD140	CPCD150	CPCD160			
M300	3000	14000	15000	16000	3340	4840	6/12
M350	3500	14000	15000	16000	3590	5340	6/12
M400	4000	14000	15000	16000	3840	5840	6/12
M450	4500	14000	15000	16000	4090	6340	6/12
M500	5000	14000	15000	16000	4340	6840	6/6
M550	5500	13000	14000	15000	4590	7340	3/6
M600	6000	12000	13000	14000	4840	7840	3/6
M650	6500	11000	12000	13000	5090	8340	3/6

G Series 14–16t heavy-load type forklift truck (ultimate version)–Standard Mast

Mast model	Max.lifting height (mm)	Load capacity (lode center 1200mm)(kg)			Overall height of mast (mm)	Max.mast height(mm)	Mast tilt angle $\alpha/\beta$ (°)
		CPCD140	CPCD150	CPCD160			
M300	3000	14000	15000	16000	3340	4840	6/12
M350	3500	14000	15000	16000	3590	5340	6/12
M400	4000	14000	15000	16000	3840	5840	6/12
M450	4500	14000	15000	16000	4090	6340	6/12
M500	5000	14000	15000	16000	4340	6840	6/6
M550	5500	13000	14000	15000	4590	7340	3/6
M600	6000	12000	13000	14000	4840	7840	3/6
M650	6500	11000	12000	13000	5090	8340	3/6

# F Configurations

Vehicle configuration											
01	Truck model	CPCD120-C2Z-09	CPCD135-C2Z-06	CPCD150-C2Z-06	CPCD160-C2Z-06	CPCD140-C2Z-09	CPCD150-C2Z-09	CPCD160-C2Z-09	CPCD140-C2Z-12	CPCD150-C2Z-12	CPCD160-C2Z-12
02	Engine	Brand	CUMMINS	CUMMINS	CUMMINS	CUMMINS	CUMMINS	CUMMINS	CUMMINS	CUMMINS	CUMMINS
		Model	QSB6.7	QSB6.7	QSB6.7	QSB6.7	QSB6.7	QSB6.7	QSB6.7	QSB6.7	QSB6.7
		Rated power ( kw/rpm)	129/2200	129/2200	129/2200	129/2200	149/2200	149/2200	149/2200	149/2200	149/2200
		Rated torque ( nm/rpm)	881/1300	881/1300	881/1300	881/1300	990/1500	990/1500	990/1500	990/1500	990/1500
		Emission standard	EU Stage V/T4F/China Stage IV	EU Stage V/T4F/China Stage IV	EU Stage V/T4F/China Stage IV	EU Stage V/T4F/China Stage IV	EU Stage V/T4F/China Stage IV	EU Stage V/T4F/China Stage IV	EU Stage V/T4F/China Stage IV	EU Stage V/T4F/China Stage IV	EU Stage V/T4F/China Stage IV
	Emission Technology Route	DOC+DPF+SCR	DOC+DPF+SCR	DOC+DPF+SCR	DOC+DPF+SCR	DOC+DPF+SCR	DOC+DPF+SCR	DOC+DPF+SCR	DOC+DPF+SCR	DOC+DPF+SCR	
03	Tank	Fuel tank(L)	280	280	280	280	385	385	385	475	475
		Hydraulic oil tank(L)	285	285	285	285	350	350	350	460	460
		Urea tank ( L )	33.5	33.5	33.5	33.5	33.5	33.5	33.5	33.5	33.5
04	Transmission	Model	ZF131	ZF131	ZF131	ZF131	ZF171	ZF171	ZF171	ZF171	ZF171
05	Drive axle	Model	Meritor drive axle	Meritor drive axle	Meritor drive axle	Meritor drive axle	Kessler	Kessler	Kessler	Kessler	Kessler
06	Tire	Size	11.00-20	11.00-20	12.00-20	12.00-20	12.00-20	12.00-20	12.00-20	12.00-20	12.00-20
07	Auxiliary configuration	Backward radar	●	●	●	●	●	●	●	●	●
		Backward image	●	●	●	●	●	●	●	●	●
		Weighting system	○	○	○	○	○	○	○	○	○
		Ops for the whole truck	●	●	●	●	●	●	●	●	●
		Ops for mast	●	●	●	●	●	●	●	●	●
08	Hydraulic system	Consistent rate system	●	●	●	●	/	/	/	/	/
		Variable system	/	/	/	/	●	●	●	●	●
09	Air conditioner	Air conditioner	●	●	●	●	●	●	●	●	●
10	Tyre	Pneumatic tyre	●	●	●	●	●	●	●	●	●
		Solid tyre	○	○	○	○	○	○	○	○	○
		Solid tyre (front), pneumatic tyre (rear)	○	○	○	○	○	○	○	○	○
		Pneumatic tyre (front), solid tyre (rear)	○	○	○	○	○	○	○	○	○
11	Cab	Tilting cab	●	●	●	●	●	●	●	●	●

●-Standard item ○-Optional item /-Not used

● Our products are subject to the improvements and changes without notice.

● The picture in the brochure may not be the standard model of this type. The configuration and color of the product in the picture may be different from the actual machine. Please adhere to the actual machine.

# G Configuration

## Mast



- **Standard type mast**  
It is suitable for normal working condition. It has changeable tread and high fatigue resistance ability.



- **Two-stage full free mast**  
It is suitable for narrow working conditions in doors, cabin and dwarf door. Extraposition lifting cylinder provides better view.



- **Three-stage full free mast**  
The truck has larger lifting height and lower truck height and thus it is safer.

## HELI smart fleet management system

- Vehicle positioning
- Remote diagnosis
- Remote monitoring
- Maintenance reminder
- Statistical form
- Vehicle management
- Identification recognition (optional)
- Weight management (optional)



## Attachments



- **Fork positioner**  
It is easy and quick with two forks adjusting powered by hydraulic.



- **Side shifting fork positioner**  
It has both space adjusting and side shifting functions to improving working efficiency.



- **Side shifter**  
Side shifting and space adjusting function are separated from each other to achieve quick respond.



- **Fork extension**  
It effectively extends fork and it is suitable for large size handling.



- **Carpet boom**  
It is suitable for roll type goods such as steel roll, wire roll and so on.



- **Crane jib**  
It is safe and high efficient to lift goods.



- **Slings**  
It is suitable for goods in bundle such as rebar, steel tube and so on.